

Maximizing System Efficiency through Effective Blowdown



Boiler blowdown is removing water from a boiler to avoid concentration of impurities during continuing evaporation of steam. The water is blown out of the boiler with some force by steam pressure within the boiler. This helps to prevent carryover, corrosion, and scaling. In short, boiler blowdown ensures high quality steam and a reliable, long-lasting boiler.

Boiler Blowdown will always have a major impact on system efficiency. Insufficient blowdown will lead to carryover of boiler water into the steam system and formation of deposits. Excessive blowdown will waste energy, water, and chemicals. Controlled Blowdown will not only lead to cost savings but also help to maintain the system efficiency.

Continuous Blowdown:

Continuous Blowdown, also called surface blowdown is an activity of extraction of water from the surface of the Steam Drum (Upper Drum). The main purpose of continuous blowdown is to remove the suspended particles from the surface of water. In the other words, Continuous Blowdown controls and limits the increase of Total Dissolved Solids (TDS) in the boiler. Increase in TDS levels will increase the surface tension of water, which will prevent the separation of steam bubbles. This will cause foaming and water carryover into steam system, which will result in various complications in steam system. Besides foaming, scaling and corrosion will also cause trouble to the boiler operation and its steam system.

How can Continuous Blowdown impact Steam System Efficiency?

During the blowdown operation, while opening the Blowdown Valve, water that contains TDS is blown out from the Drum. The water, at a very high pressure and temperature, when it passes through the orifice of the valve, will have serious wire drawing and cavitation impact on the valve plug control and sealing surface.

Depending on the requirements, the Boiler Steam Drum Pressure will be up to 2500# and the outlet of Continuous Blowdown Valve will generally be connected to the Blowdown tank or the Flash Tank, which will be maintained at a pressure class of 150#. As per the figure (a), water leaves the valve with a very high pressure drop without any variation in temperature. This causes formation of water vapour bubbles. As the pressure will be above the vapour pressure of water, the vapour bubbles will implode resulting in cavitation. This will result in quick need for valve servicing or replacement.

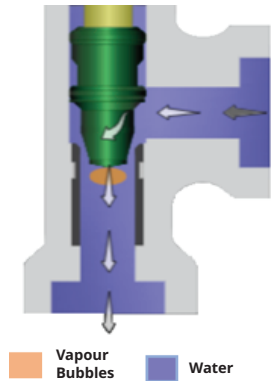

Figure (a)

Intermittent Blowdown:

Intermittent Blowdown, also called bottom blowdown is extraction of water from the Water Drum (Lower Drum). As the high pressure, high velocity water travels through pipes and equipment, it has capability to erode the pipes and carry debris along with it in addition to the non-soluble particles in the water. These particles get deposited in the bottom of the water drum. The intermittent Blowdown Valve is used to remove the water containing non-soluble particles from Water drum.

How can Intermittent Blowdown impact Steam System Efficiency?

The valve, to remove the non-soluble particles, should have sufficient flow path to avoid blockage. Also, presence of dams and pockets in the valve will cause accumulation of debris. Over the period of time, the high velocity water carries the accumulated debris and causes serious impact on downstream equipment/bends. This will have an impact on performance of the valve resulting in repeated servicing of the valves.

Secondly, as per ASME B31.1 Sec 122.1.7 'c' clause 10, Intermittent Blowdown applications require two slow opening valves or one fast opening and one slow opening or two valves combined on one body. The Sealing Valve is connected at downstream from Boiler, which is followed by the Blowing Valve, which is connected to the blowdown tank. The Sealing valves is to be opened first followed by Blowing Valve. During closing, the Blowing Valve is to be closed first followed by the Sealing Valve.

The following scenarios will impact the Intermittent Blowdown system:

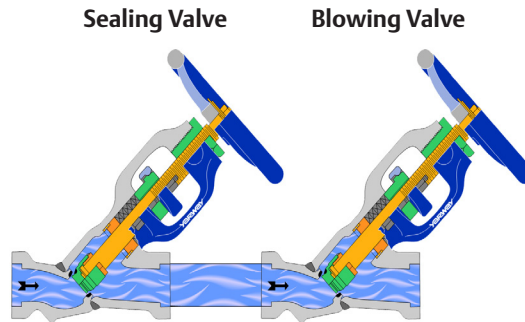

Figure (b)

Figure (b) shows the arrangement of 2 valves. The Blowing valve will face the impact of high Differential Pressure, which will cause it to damage much faster. Replacement of the valve will have high-cost implication as compared to in-line servicing.

1. As sealing valve is close to the boiler, it will be subjected to boiler heat, whereas blowing valve will be cold. Immediate opening of sealing valve will have huge impact of heat energy on cold blowing valve, which will cause Thermal Damage to the Blowing Valve.
2. Arrangement of 2 valves in line will also present leakage opportunities due to multiple welds and flanges.

Can any valve be used for BLOWDOWN?

Note below the very important excerpts from ANSI/ASME B31.1-1986 Para 122.1.4, 122.1.7.c:

- Ordinary globe valves as shown Figure (a), and other types of valves that have dams or pockets where sediment can collect, shall not be used on blowoff connections.

Result: As high pressure water travel at a very high velocity, it can carry the deposited debris along with and can cause huge impact on any equipment at its downstream

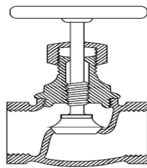

Figure (a)

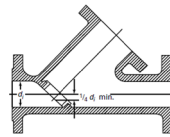

Figure (b)

- Y-type globe valves as shown in Figure (b) or angle valves may be used in vertical pipes, or they may be used in horizontal runs of piping provided they are so constructed or installed that the lowest edge of the opening through the seat is at least 25% of the inside diameter below the centreline of the valve.

Result: Blowoff application can contain large non-soluble particles that can get trapped in the orifice section of the valve thereby choking the valve and preventing any discharge. This will cause clogged blowoff line and possibilities of non-soluble particles getting deposited in the water wall tubes or even riser and downcomers, which will result in huge heat concentration in deposit areas and can cause tubes puncture.

- Two independent slow-opening valves, or a slow-opening valve and a quick-opening valve as per Figure (c) are required in the blowoff system (Intermittent Blowdown). The Sealing Valve (Close to Drum) can be a quick opening or slow opening; however the Blowing Valve (To Drain) has to be slow opening.

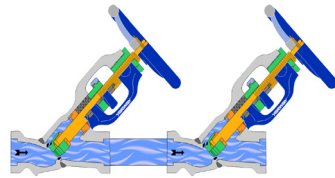

Figure (c)

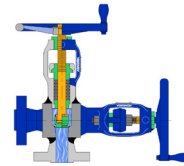

Figure (d)

Result: With the provision of two valves, the blowing valve is usually subjected to two types of damages (i) Damage due to high differential pressure as the blowdown tank will be close to atmospheric pressure or slightly above and (ii) Damage due to Thermal Effect of opening of sealing valve as the blowing valve will generally be cooler when the sealing valve is closed. To avoid second damage generally Tandem Blowdown Valves used as per Figure (d).

How to Optimize the Blowdown System Efficiency and Conserve Energy?

Several factors can contribute to reduced energy consumption on the water side of steam generation equipment. Depending on the process parameters, the water that is blown down from boiler has very high temperature and hence potential heat energy source.

- Scale Reduction:** Scale reduction through proper pre-treatment and internal chemical treatment results in cleaner internal surfaces for more efficient heat transfer and resultant energy savings.
- Optimize Blowdown Rate:** A reduction in boiler water blowdown can result in significant fuel and water savings. Adjust the blowdown rate accordingly.
- Avoid Quick Opening Valves:** High pressure water travelling at high velocity can erode the components very quickly. Quick opening valves will increase the velocity of water that will cause Water Hammer Effect.
- Optimize Blowdown Valves:** Install and maintain modulating blowdown control valves that allow for precise control of blowdown rate based on water quality.
- Inline Repairability:** Any valve on high pressure and high temperature water service is bound to fail quickly. In-line repairability will ensure reduced cost due to manhours and system downtime.
- Explore Advanced Technologies:** Pneumatic and Motorized Blowdown systems can continuously monitor and adjust blowdown rates based on real-time water quality data.
- Benchmark Best Practices:** Compare your blowdown system's performance to industry benchmarks and adopt best practices for blowdown management.
- Education and Training:** Education on importance of proper blowdown procedures is necessary for energy and water consumption.
- Heat Recovery:** Boiler Blowdown is also huge source of heat energy. Recovering the heat energy will have huge positive impact on steam system.

Refer the below schematic to harness the energy from Blowdown.

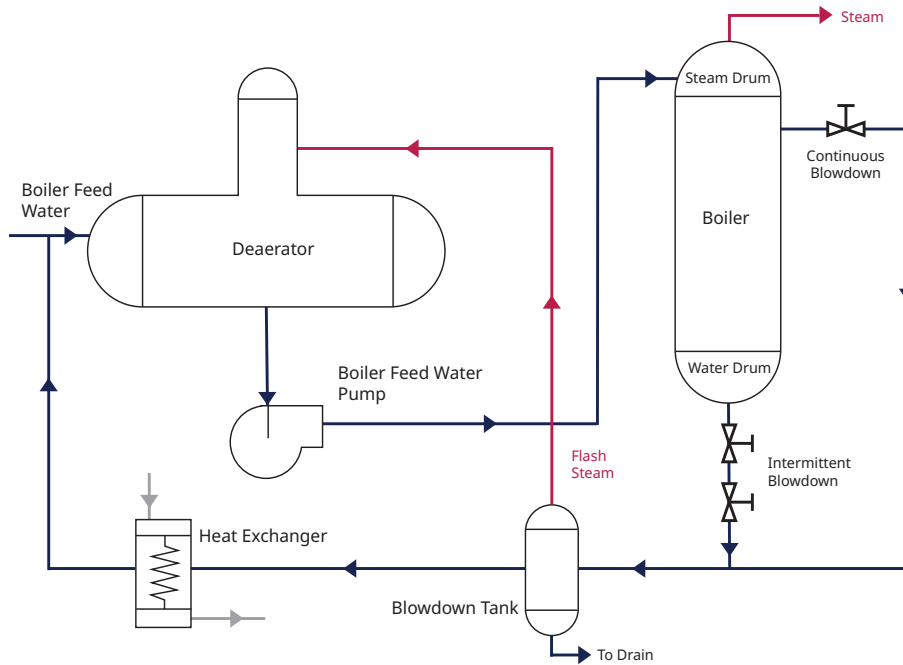

Hot water from Boiler, through Continuous and Intermittent Blowdown is collected in the Blowdown Tank. The Hot water, as it enters the Blowdown Tank, releases Flash Steam, which by virtue of density is collected on top. This hot water and Flash steam still carries heat energy, which can be utilized. Hence the water from Blowdown tank either can be directly transferred to Deaerator to increase the energy of boiler feed water or to a Heat Exchanger to utilize the heat energy, whereas Flash steam can either be supplied to Deaerator or Boiler Feed Water Tank to help boiler improve the efficiency.

With all the highly competitive product features and unparalleled value-added services, Emerson is a one-stop shop for all your Smart and Efficient Blowdown needs. With our long trusted technical expertise and strong market leadership, we would be happy to partner with you. Reach out to us so that we can GO BOLDLY together in the safety journey.

Emerson Automation Solutions

1 Pandan Crescent
Singapore 128461
T +65 6777 8211

www.Emerson.com

Neither Emerson, Emerson Automation Solutions, nor any of their affiliated entities assumes responsibility for the selection, use or maintenance of any product. Responsibility for proper selection, use and maintenance of any product remains solely with the purchaser and end user.

The contents of this publication are presented for informational purposes only, and while every effort has been made to ensure their accuracy, they are not to be construed as warranties or guarantees, express or implied, regarding the products or services described herein or their use or applicability. All sales are governed by our terms and conditions, which are available upon request. We reserve the right to modify or improve the designs or specifications of such products at any time without notice.