

Distillation Column Flooding Diagnostics with Intelligent Differential Pressure Transmitter

Distillation is a common unit operation, which is used to separate or purify components in a feed stream. Flooding is a common abnormal process condition wherein the distillation column stops generating a separation, thus causing the quality of the top and/or bottom products to go off specification. The Rosemount 3051S Pressure Transmitter with Advanced Diagnostics can be used to detect incipient flooding in real time, and provide an early warning. Figure 1 illustrates the results of a field test in which flooding was deliberately and repeatedly triggered by increasing the heat supplied to the reboiler. The standard deviation, provided by the Rosemount transmitter, increases each time flooding is triggered; from which, an incipient flooding alert threshold can be defined. When this threshold is exceeded, it indicates the distillation column is still producing a good separation; but, is about to flood. Because this technique detects a physical phenomena intrinsically associated with flooding, it is believed to be widely applicable. Users of Rosemount DP transmitters with Advanced Diagnostics will be able to confidently push their distillation columns closer to their operational limits and quickly eliminate flooding as a root cause of product quality issues.

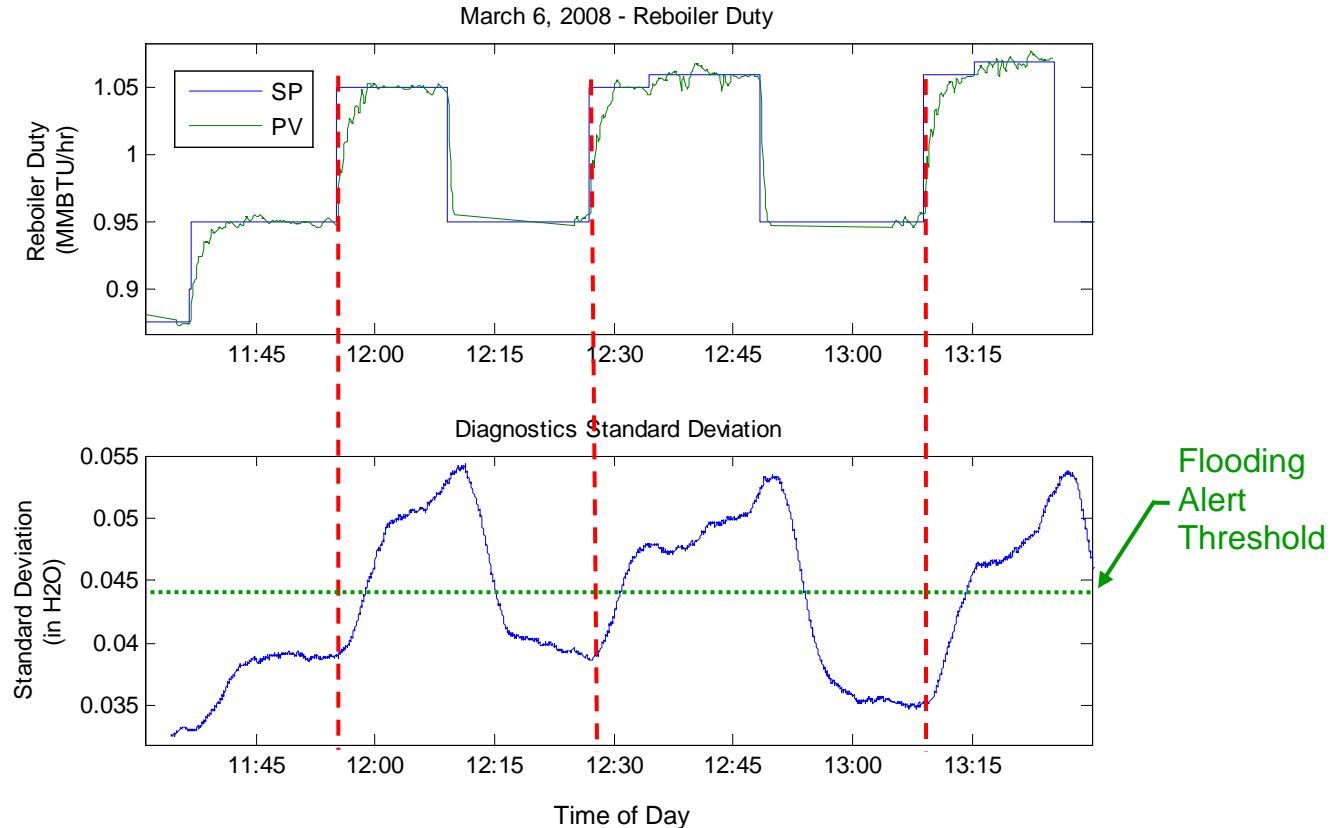

Figure 1 – Robust Flooding Alert

Introduction

Distillation is a process used across many industries, including refining and chemical. In a distillation system a feed stream containing a mixture of components is separated or purified into two or more product streams enriched in certain feed components and depleted in others. Distillation is probably the most common separation or purification process in use today.¹ The process of distillation is very energy intensive and can contribute to more than 50% of plant operating costs.¹ Thus, there is great interest in operating distillation columns as efficiently and reliably as possible.

Figure 2 illustrates the basic components of a distillation system.² A feed stream, usually liquid, consisting of a mixture of components to be separated, is fed into a vessel. This vessel is usually a tall cylinder in shape, standing vertically and is commonly referred to a “distillation column”.

Inside the vessel are structures designed to cause intimate radial mixing (i.e. mixing at any given vertical level); but, not axial mixing (i.e. mixing along the length of the vessel) and contact area between a stream of vapor flowing up and a stream of liquid flowing down. These structures can take the form of discrete “trays” or “stages” or they can be in the form of packing. Packing can be either randomly dumped shapes with names like “Rashig Rings”, “Beryl Saddles”, etc., or the packing can be a so-called “structured packing” such as “Koch Flexipack[™]”.

The purpose of all these different types of column internal structures is the same: to facilitate vapor/liquid contacting and mass transfer. The part of the distillation column above the feed point is commonly referred to as the “Enriching Section” or the “Rectification Section”. The part of the distillation column below the feed point is known as the “Stripping Section”.

Liquid trickles down the column, exits the bottom of the Stripping Section, and flows into the reboiler. The reboiler is a special type of heat exchanger that uses steam or some other heat transfer fluid to heat the liquid in the reboiler to its boiling point. The vapor generated by this boiling liquid exits the reboiler and is fed back into the Stripping Section of the column. Excess liquid in the reboiler overflows a weir and exits the process as the “Bottoms Product”, sometimes referred to as the “Bottoms”.

The vapor from the reboiler flows up the column, countercurrent to the liquid flowing down the column. The components in the feed stream are separated according to their relative boiling points. Components with a lower boiling point tend to become enriched in the vapor traveling up the column. Components with a higher boiling point tend to become enriched in the liquid traveling down the column. Eventually, the vapor enriched in low boiling components exits the Rectification Section on the top of the distillation column. This vapor is condensed back to a liquid by cooling in a heat exchanger called the condenser. The condensed liquid is collected in the reflux drum. A portion of the condensed liquid is fed back into the Rectification Section to become the liquid flowing down the column as described previously. The rest of the liquid exits the process as the “Top Product” or the “Distillate”.

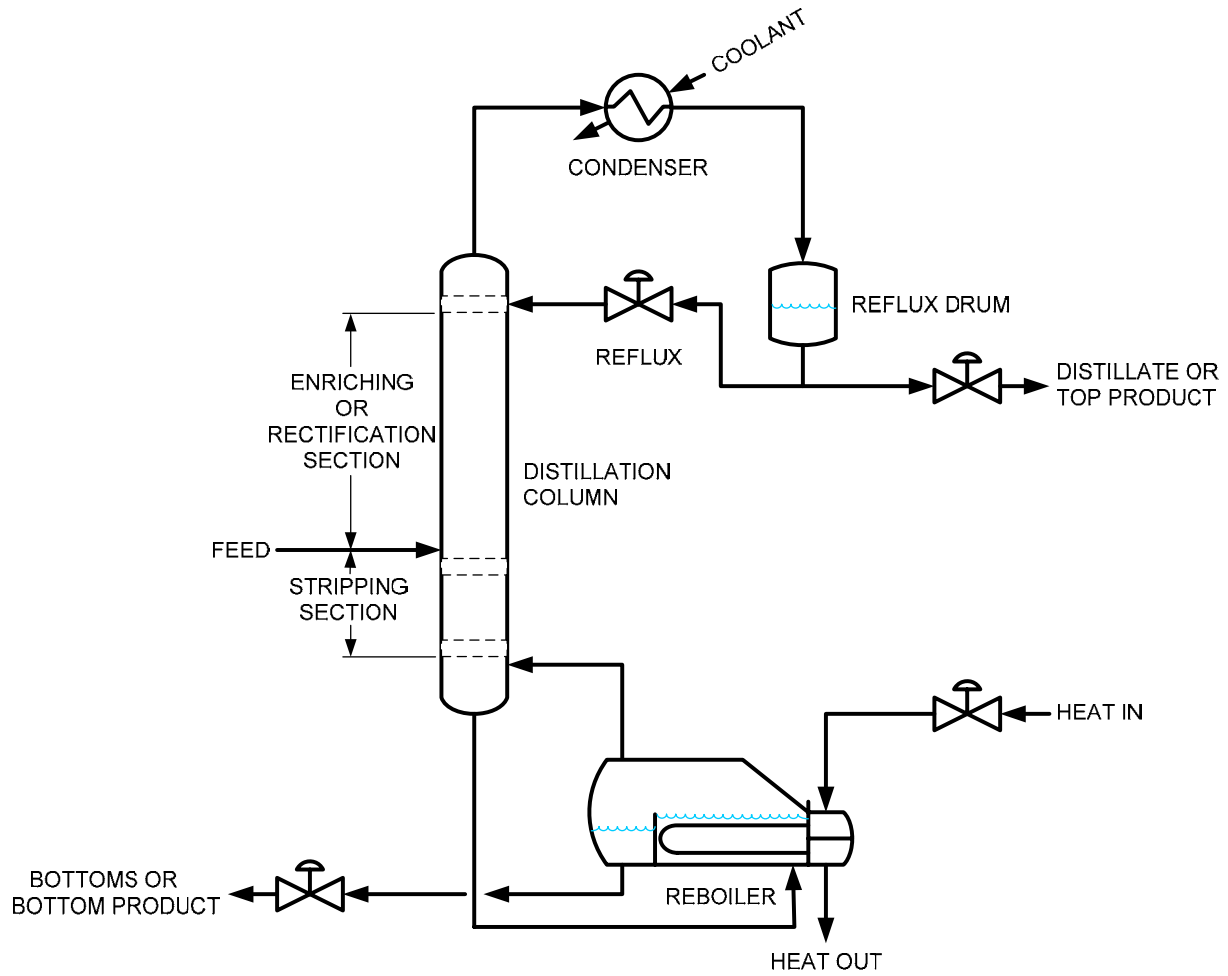

Figure 2 - Basic Components of Distillation

Challenge: Flooding in Distillation Columns

A common problem that can occur in distillation columns is flooding. Figure 3 illustrates a cross section through a distillation column, filled with a structured packing, showing the liquid flow and vapor flow when the column is operating normally. Liquid is flowing downward over the structured packing countercurrent to the upward flowing vapor. The vapor must follow a tortuous path; but, the void space in the packing is predominantly filled with vapor. The vapor is said to be the “continuous phase”. The upward flow of the vapor exerts an “aerodynamic drag” on the falling liquid. This drag force acts in opposition to the force of gravity and slows the flow of the falling liquid. When the relative flow rates of the vapor and liquid are such that the drag force is greater than or equal to the gravity force; then, the liquid stops flowing down the column. This condition is called flooding. Flooding can begin at any vertical location in the column.

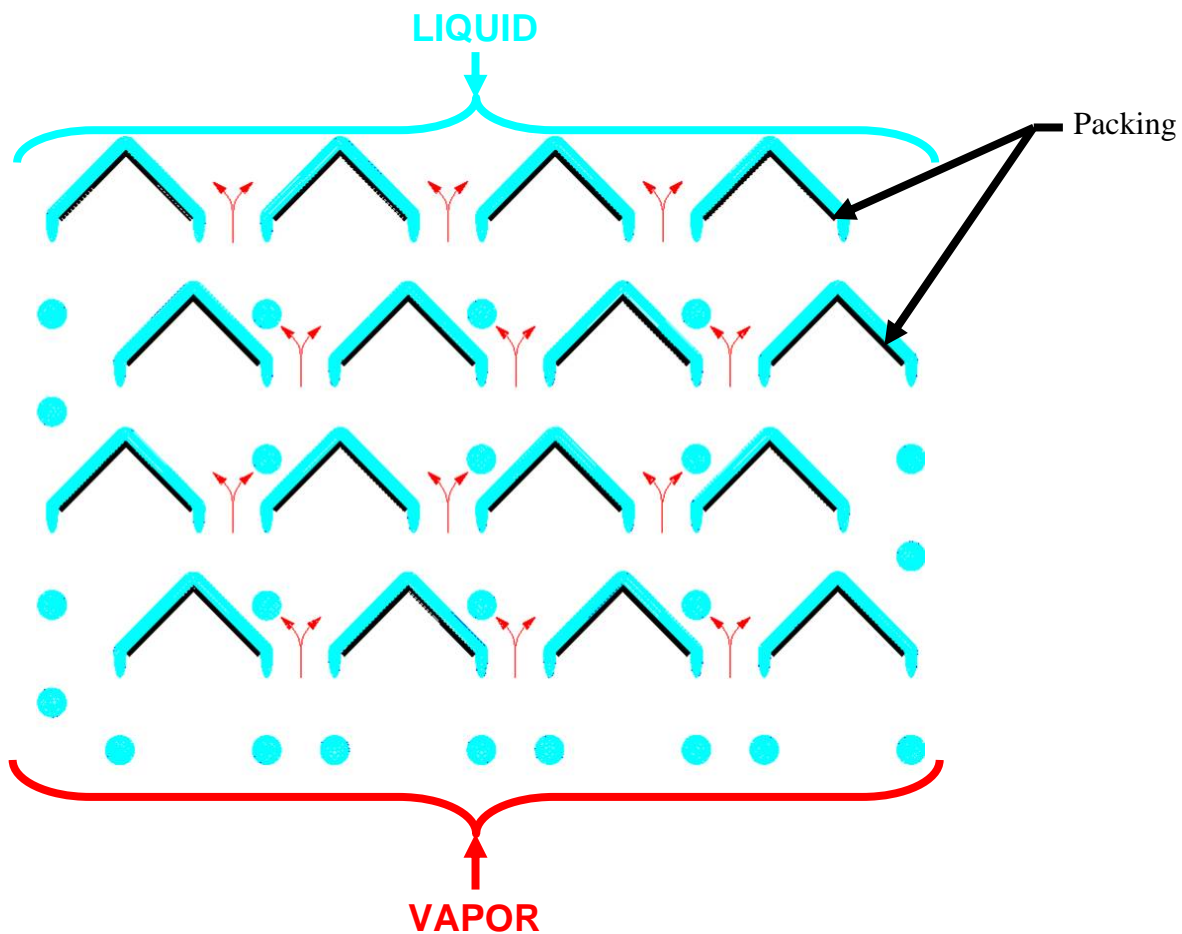

Figure 3 - Normal Condition: – Vapor Flow Is Continuous Phase with Falling Liquid Droplets

Figure 4 illustrates the same cross section through the column as Figure 3 except the column is flooding.

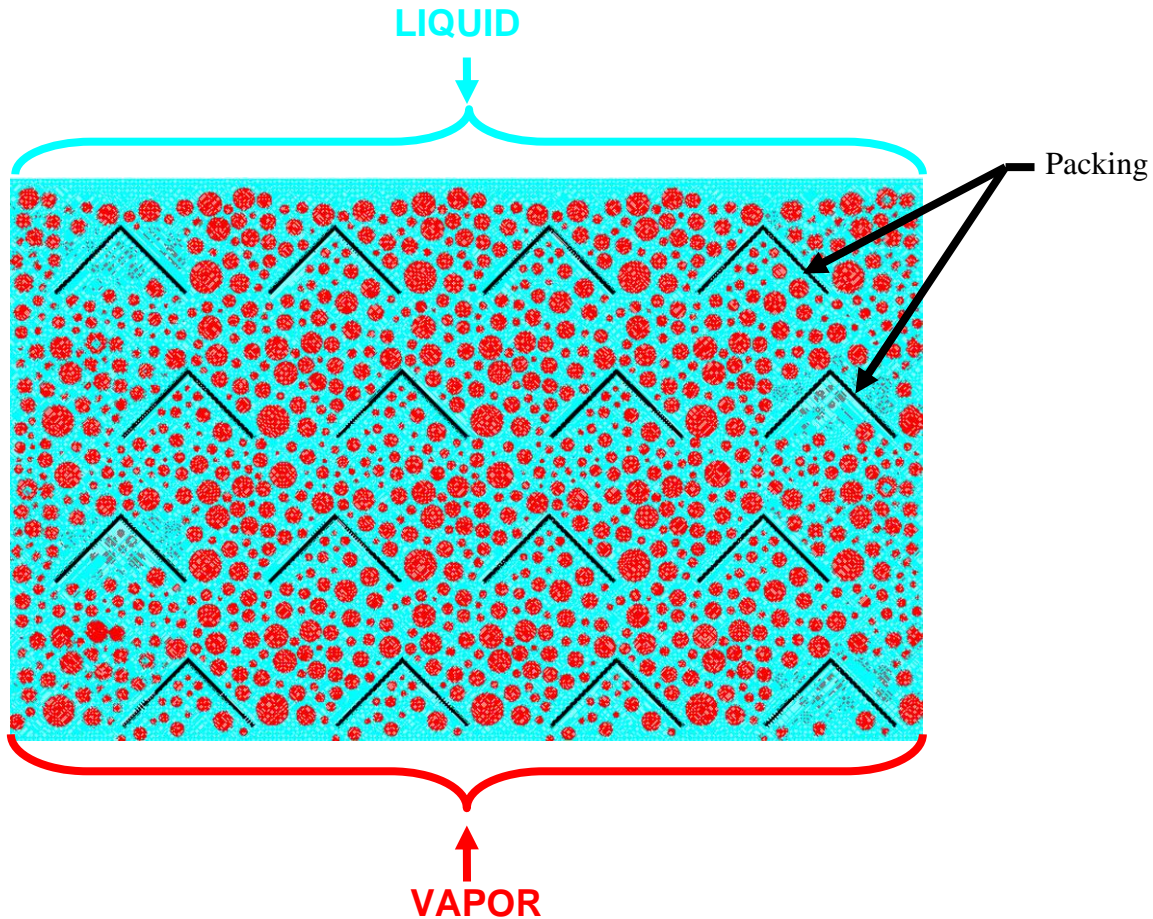
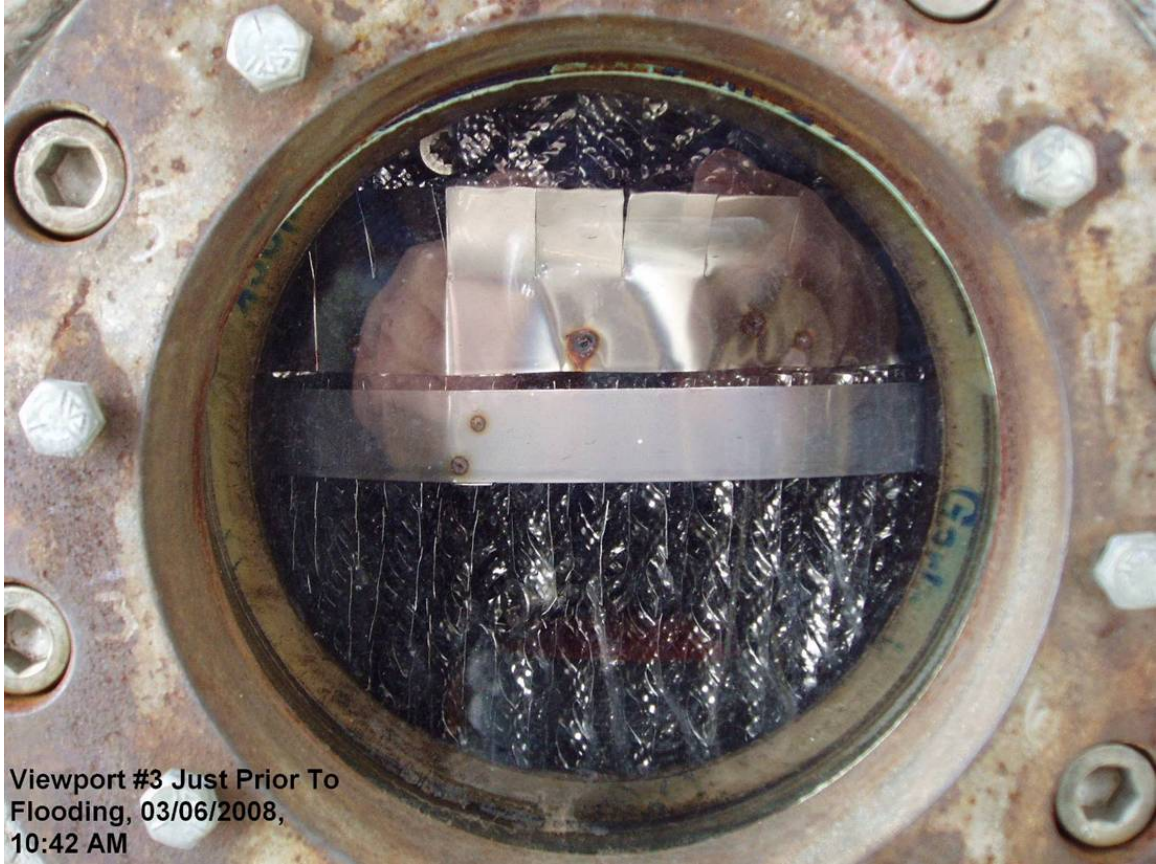

Figure 4 - Flooded Condition: Vapor Flow Becomes Rising Bubbles in Continuous Liquid Phase

Note how the flow regime has changed. The liquid is now the continuous phase with bubbles of vapor rising through it. The rising bubbles tend to drag a lot of liquid upward, thus causing undesirable axial mixing in the column. The net effect is the distillation column stops generating a separation and the top product and the bottom product become similar in composition to the feed stream. The bubbles have a distribution of sizes and tend to nucleate, grow, agglomerate, and break apart randomly. As a result, bubble flow tends to be a random, chaotic process. If the pressure drop were measured across the packing, it is expected this random bubble flow process would contribute a broad spectrum or “white noise” component to the pressure drop signal. This white noise component is not expected to be present during normal operation.

Figure 5 shows the conditions visible through a sight glass in a distillation column filled with a structured packing in normal operation. Note the open void space within the packing with liquid weeping out of the packing at several points.



Viewpoint #3 Just Prior To
Flooding, 03/06/2008,
10:42 AM

Figure 5 – Viewport #3 with Column in Normal Operation

Now, contrast Figure 5 with the view through the same sight glass when the column is flooding in Figure 6. The highly chaotic bubble flow is quite evident. A motion picture of the fluid action in Figure 6 would resemble the view through the viewing port on a front loading clothes washing machine.

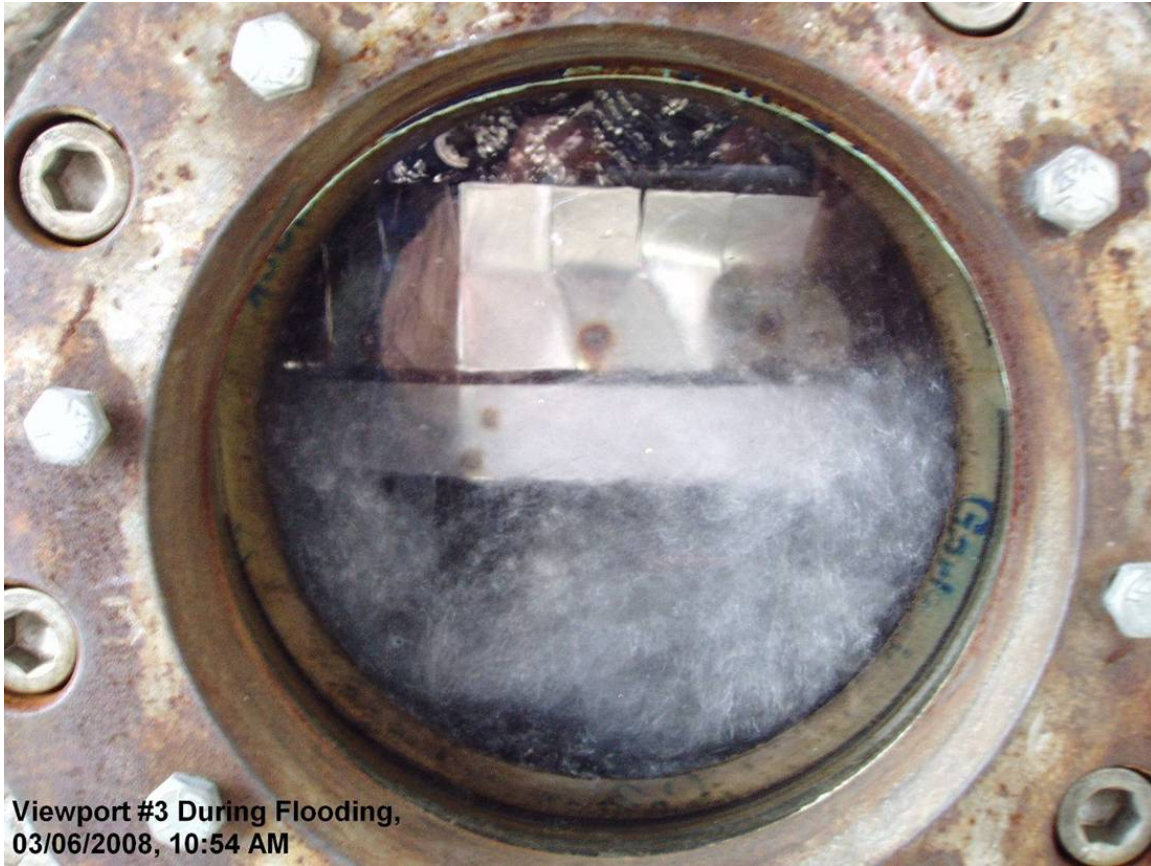

Viewport #3 During Flooding,
03/06/2008, 10:54 AM

Figure 6 - Viewport #3 with Column Flooding

In actual practice, distillation columns usually have numerous control loops, running in Auto, controlling process parameters like feed rate, column pressure, reboiler heat duty, reflux ratio, top and/or bottom product compositions, various temperatures, etc. The action and interaction of these control loops can make detection and diagnosis of flooding difficult.³ In order to make it easier to study flooding in distillation columns; it is common practice to simplify the operation of the system. Figure 7 illustrates how this is accomplished, by eliminating the feed stream into the column as well as the distillate product and bottom product streams out of the column. Instead, all of the condensed top product is sent back down the column as liquid reflux. All of the bottom product is boiled back up the column as vapor by the reboiler. Distillation columns operating in this mode are said to be on “total reflux” or “100% reflux mode”. In 100% reflux mode, the only process parameter that can be changed is the reboiler heat duty. Flooding is triggered by increasing the reboiler heat duty. Increasing the reboiler heat duty causes more vapor to be boiled up, which increases the vapor flow up the column. Eventually, the increasing vapor flow rate exceeds a critical threshold and triggers flooding.

Although Figures 3 and 4 may imply that flooding is simply a discrete, on/off phenomenon, this is not necessarily true. In a typical distillation column, as the relative vapor velocity is increased, development of flooding tends to be a continuous phenomenon wherein liquid droplets start to get entrained in the upward vapor flow. As the relative vapor velocity continues to increase and the column continues to approach a flooded state, the bulk density of the fluid within the packing void space increases until it approaches the condition depicted in Figure 4.

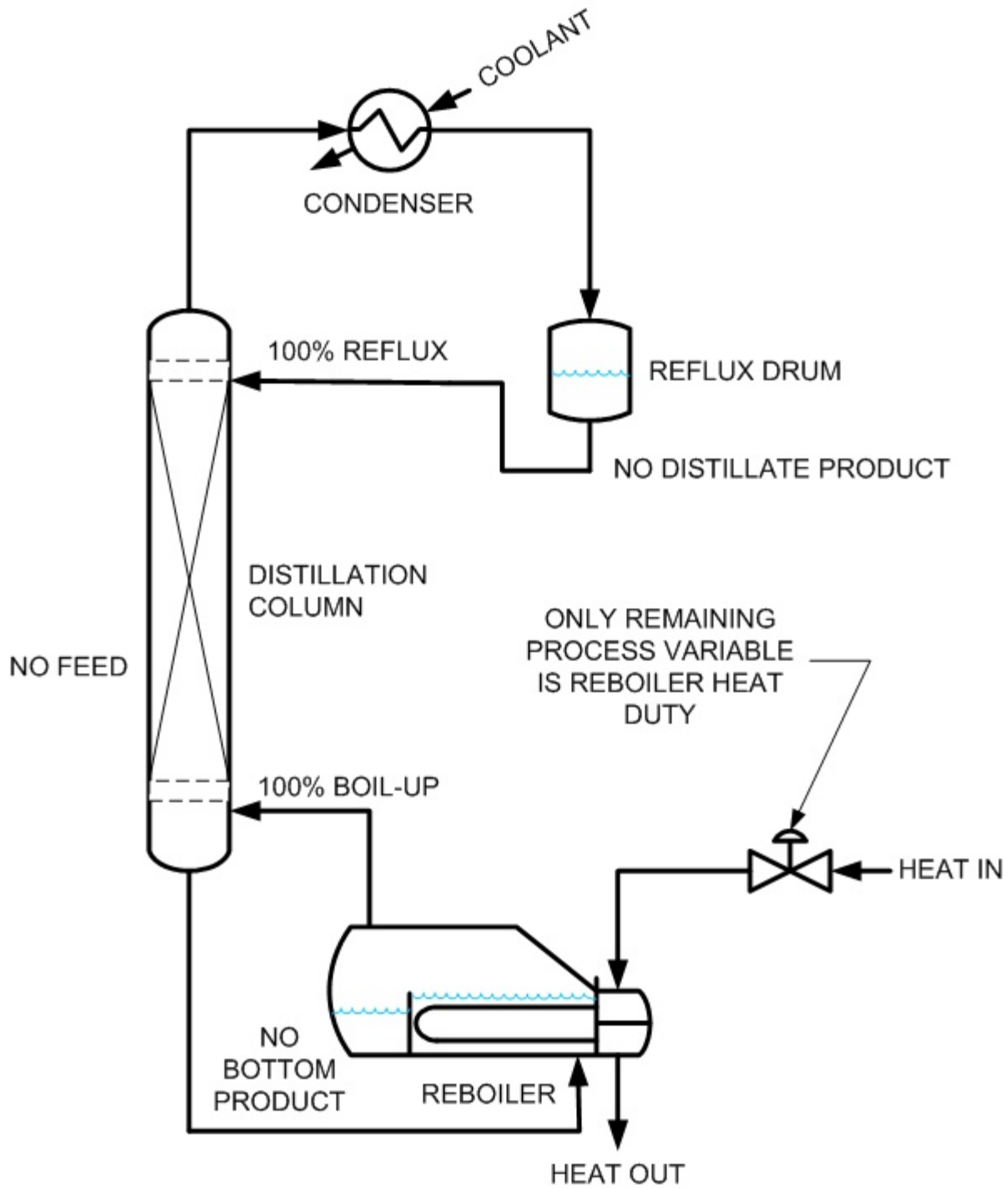

Figure 7 - 100% Reflux Mode

The condition depicted in Figures 4 and 6 is sometimes referred to as “Runaway Flooding”. In Runaway Flooding, the liquid level continues to rise until the entire column is filled with frothy liquid. If Runaway Flooding is not stopped, the column can actually overflow and send liquid into the distillate process lines.

For any given distillation column, exactly what stage in the development of flooding can be detected will be dependant upon such factors as:

1. Column length over which the DP measurement is taken. Shorter column length will enable more sensitivity to detect flooding over that section of column. In actual practice, the DP across the Stripping Section and the Rectification Section of the column might be measured separately to detect flooding independently in each section.
2. $[DP] / [Absolute\ Pressure]$ ratio in the column. A greater $[DP] / [Absolute\ P]$ ratio will make the measurement more sensitive to detect flooding.
3. Presence and length of DP transmitter impulse lines. Long impulse lines tend to attenuate the high frequency signals this technique depends on to detect flooding conditions.

Ideally, one would like to detect flooding in the distillation column before it reaches the point of Runaway Flooding. Thus, an ideal diagnostic for distillation column flooding detection would show that the column is approaching the Runaway Flooding condition. (i.e. one that shows that the column is beginning to flood.) This condition will be referred to as “Incipient Flooding”.

Field Experiment

A field experiment was conducted at the J.J. Pickle Research Campus of the University of Texas, Austin, on March 5-6, 2008. The field experiment used an 18-inch-diameter scale distillation column operated by the U.T. Separation Research Program. During this field experiment, the column was operating in 100% reflux mode. Under this mode, the reboiler heat duty could be increased incrementally until flooding was observed. The distillation column is instrumented with Foundation Fieldbus devices, and DeltaV is used as the distributed control system.

Figure 8 illustrates the operator interface for this distillation column.

In this experiment, the structured packing only filled the bottom half of the column. A Rosemount 3051S Foundation Fieldbus differential pressure transmitter (Range 1: -25 to 25 inches of water) was installed on the distillation column across the packing section. A specialized data acquisition system was used to log the pressure signal at the same rate as sampled within the transmitter (approximately 22 Hz). By logging the raw-sampled process data, it would be possible to determine optimal SPM configuration settings (e.g. filter and sample window size) for detecting flooding.

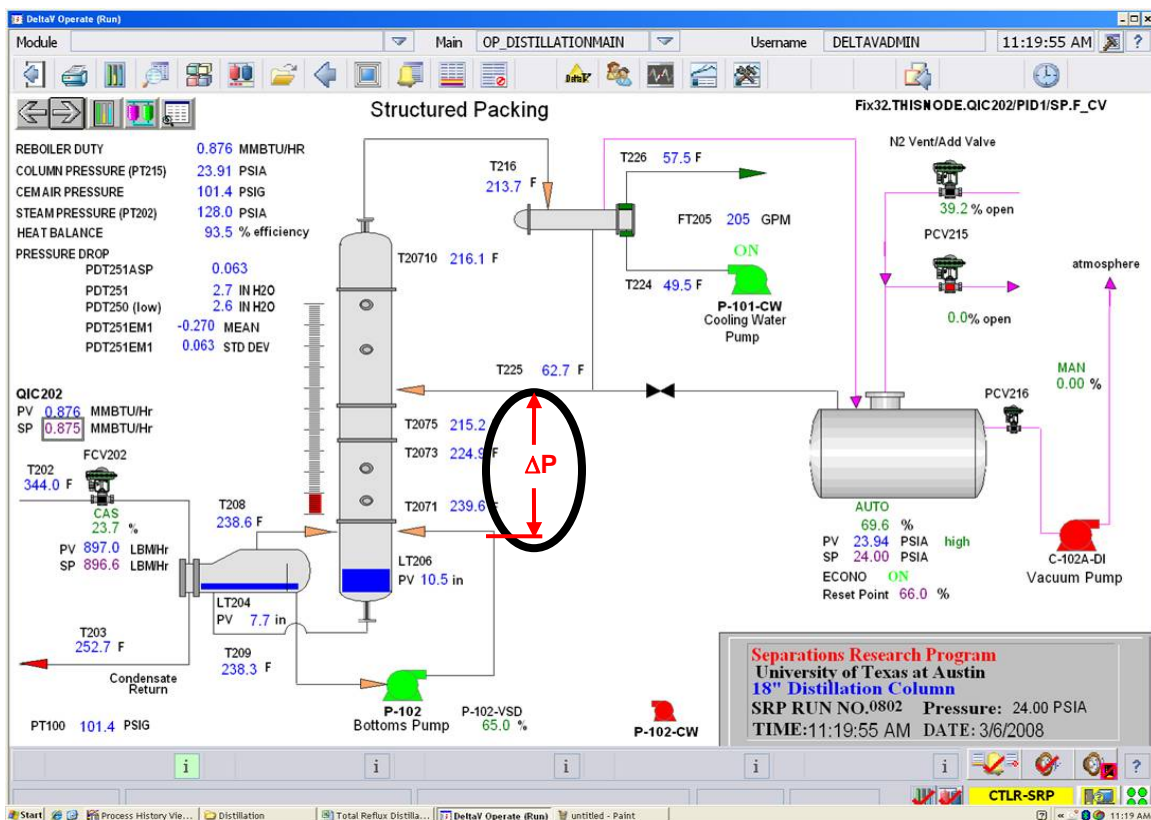

Figure 8 – Operator Interface for Distillation Column Control & Showing Location of ΔP Measurement

During a first flooding test, the reboiler duty was increased in small steps. Table 1 shows the events and observations during this first flooding test.

Table 1- Events during Flooding Test 1

Timestamp	Reboiler Duty (MMBTU/hr)	Observation
Initial	0.875	
11:32:03 AM	0.95	
11:45:27 AM	1.025	
11:55:36 AM	1.05	
12:08:25 PM	1.075	
12:14:00 PM	1.075	Bubbling
12:14:30 PM	1.075	Flooding in Lower Sight Port
12:15:30 PM	1.075	Flooding in Upper Sight Port
12:16:06 PM	1.075	Upper Sight Port Fully Flooded
12:19:00 PM	0.875	
12:19:40 PM	0.875	No Flooding in Upper Sight Port
12:19:54 PM	0.875	No Flooding in Lower Sight Port

Figure 9 shows time-plots of the relevant process variables during the first distillation column flooding test. The top plot shows the reboiler duty (both setpoint and actual value). The middle plot shows temperatures around the packing bed (top, middle, and bottom) as well as the vapor inlet temperature. The bottom plot shows the standard deviation calculated by the 3051S transmitter.

At 11:32 AM, the reboiler duty was raised from 0.875 to 0.95 MMBtu/hr, which is an operating point at which, based on operator knowledge, the distillation column should be running normally, e.g. not within the range of flooding. The sight ports looked like Figure 5, with the liquid droplets trickling down.

From that point on, the reboiler duty was increased further, each time moving the column closer to the Runaway Flooding condition. At 11:45 AM the reboiler duty was raised to 1.025 MMBtu/hr, and at 11:55 the reboiler duty was raised again to 1.05 MMBtu/hr. Both of these were operating points at which it was expected, based on operator knowledge, that the column was likely getting close to the Runaway Flooding condition. However, at both of these points, the DP leveled off to a steady-state value, and the sight port still looked like Figure 5. Because the column was getting close to flooding, but flooding was not actually observed, we will call this time segment the “Incipient Flooding” condition.

At 12:08 PM, the reboiler heat duty was raised again, this time to 1.075 MMBtu/hr. About 6 minutes later is when flooding was first observed in the lower sight port (Figure 6), with frothy liquid gradually filling the viewport from the bottom.

The top plot in Figure 10 shows the raw 22 hz bed-packing DP signal during Normal, Incipient Flooding, and Runaway Flooding. Note how each time the reboiler heat duty was raised, the DP also increased. It is important to note; that, prior to achieving the Runaway Flooding condition, each time the DP increased, but leveled it out at a new steady state. However, when the reboiler heat duty was increased to the point of triggering Runaway Flooding, the DP continued to increase and did not level off.

Referring back to Figure 9, when Runaway Flooding occurred; the bottom, middle, and top temperatures of the distillation column packing bed begin to converge. This is seen by the increase in bed middle and bed top temperatures around 12:15 PM. This temperature convergence during flooding is caused by the increased axial mixing as previously described. Typically, a plant operator can know that flooding has occurred only by looking at the trend of these temperatures. However, as can be seen in Figure 9, these

temperatures converge only after the Runaway Flooding condition has been occurring for several minutes and thus cannot be used to detect Incipient Flooding.

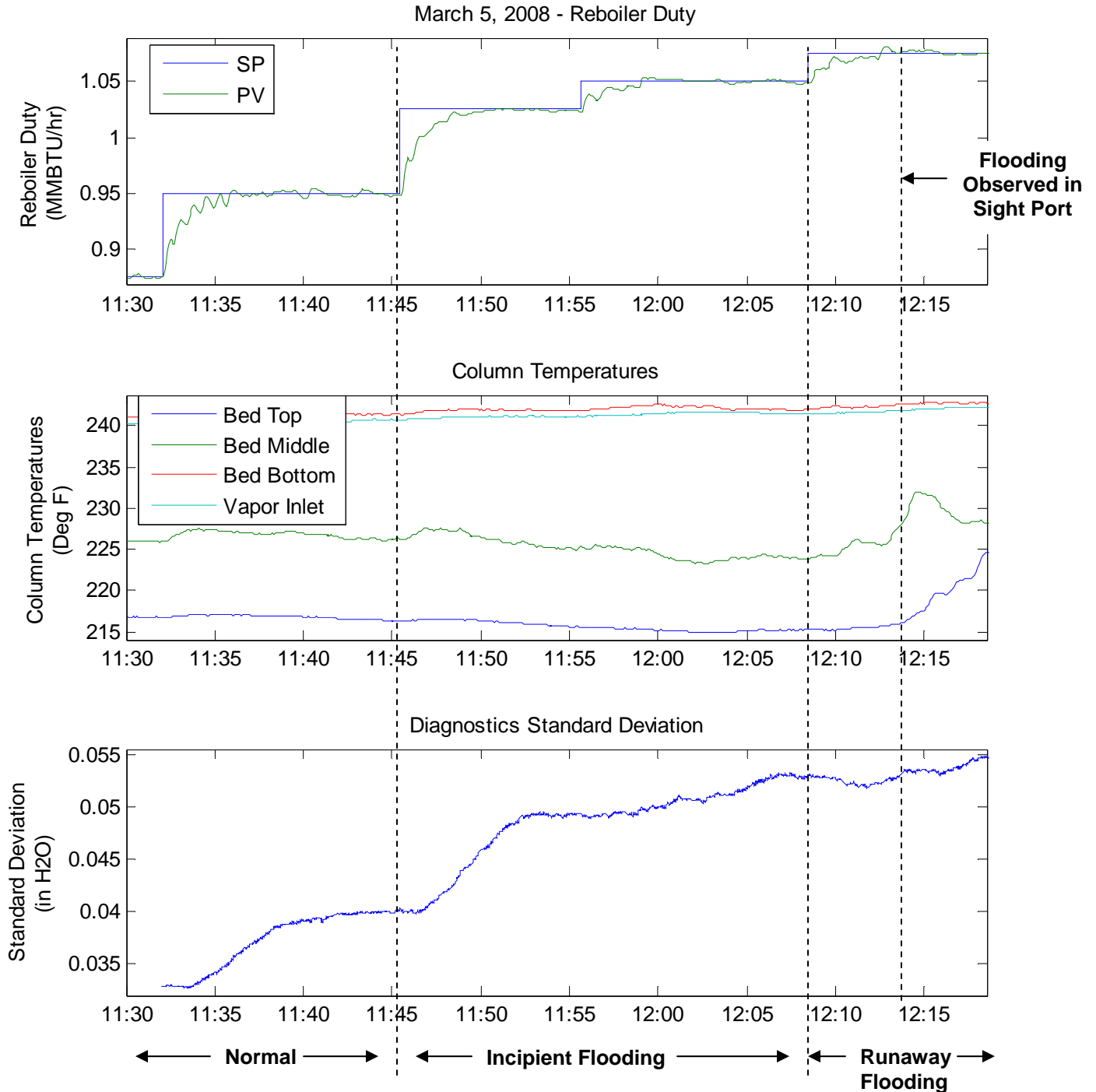

Figure 9 - Time-plots during Flooding Test 1

The test data was divided into three segments (Normal, Incipient Flooding, and Runaway Flooding) as shown in Table 2

Table 2 - Data Classification for Test 1

Data Set	Reboiler Duty (MMBtu/hr)	Time Range
Normal	0.875, 0.95	11:30 AM – 11:45 AM
Incipient Flooding	1.025, 1.05	11:45 AM – 12:08 PM
Runaway Flooding	1.075	12:08 PM – 12:19 PM

A frequency analysis was done in order to determine an optimal digital filter for this application. The top plot of Figure 10 shows the raw 22 Hz data collected from the 3051S, and divided into three segments: Normal, Incipient Flooding and Runaway Flooding. The bottom plot in the figure shows a power spectral density analysis done on each of these three data segments. Because the signal was sampled at 22 Hz, the range of the frequency spectrum is from 0 Hz to 11 Hz (the Nyquist frequency).

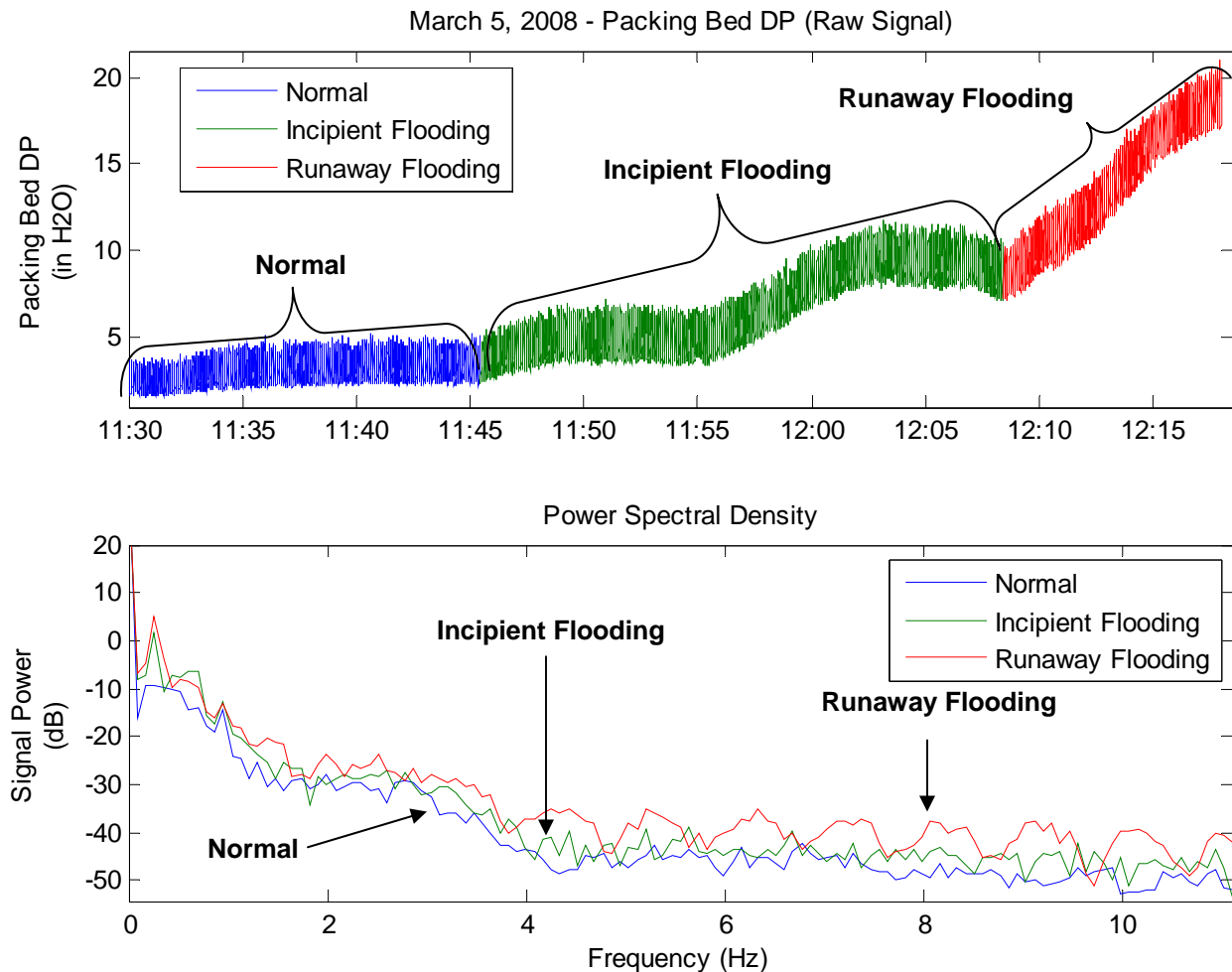

Figure 10 – Test 1: Power Spectrum Analysis of Pressure Signal Before and After Flooding

In the low frequency range (less than 2 Hz); the power spectra between these three data sets are fairly closely matched. However, in the higher frequency ranges (greater than 4 Hz), there is clearly a difference between the Normal condition, the Incipient Flooding condition, and the Runaway Flooding condition. In the higher frequency range, the power spectrum for the Incipient Flooding Condition is higher than for the Normal condition, and the power spectrum for the Runaway Flooding condition is higher than for the Incipient Flooding condition. Because the greatest difference in the frequency spectrum is at the higher frequencies, a good filter for detecting flooding would be one that cuts out lower frequencies, while passing higher frequencies.

The Advanced Diagnostics feature of both the HART and Fieldbus Rosemount 3051S pressure transmitters contains a user selectable, first-order digital high-pass filter (the differencing filter), which cuts off the lower frequency signals (including setpoint or transient changes), while passing the higher frequency noise.

The bottom plot of Figure 9 shows the standard deviation (using a 5-minute rolling window) of the high-pass filtered pressure signal. Each time the reboiler duty is increased, the standard deviation also increased. In the Incipient Flooding condition, the standard deviation is significantly greater than in the Normal condition. Note; that, because a 5-minute rolling window was used for the standard deviation calculation, it takes at least that long for the standard deviation to reach its final value, after the reboiler duty was increased. Note also; that, the standard deviation is even greater when the distillation column transitions to the Runaway Flooding condition.

Therefore, one can clearly see that the filtered standard deviation gives an indication that the distillation column is approaching the flooded condition. By trending this filtered standard deviation, the plant operator is given an early warning that the distillation column is approaching the flooding point. In this way, an abnormal situation may be prevented.

It should be noted that a variety of other high-pass filters were also tried, and using these different filters, both the filtered signal, and the filtered standard deviation were plotted. However, none of them worked any better than the differencing filter for detecting incipient flooding.

Repeatability of Flooding Detection

Figure 1 illustrates another flooding test, in which the reboiler duty was repeatedly changed between the Runaway Flooding condition (reboiler duty = 1.05-1.07), and the Normal condition (reboiler duty = 0.95). The top plot shows the reboiler duty, while the bottom plot shows the 5-minute filtered standard deviation. Notice that each time after the process is changed from the Normal condition to the Runaway Flooding condition, the filtered standard deviation increases. Furthermore, notice that it is possible to create a threshold on the standard deviation which detects Incipient Flooding in all three cases. When the standard deviation exceeds the threshold, it is an indication that although the separation quality is currently good, the distillation column is approaching the Runaway Flooding condition. This test demonstrates the repeatability of creating a flooding alert, based upon the filtered standard deviation.

Conclusion

Distillation Column Flooding is a phenomenon that can cause loss of separation and negatively impact the performance and energy efficiency of the distillation process. The onset of distillation column flooding is associated with a change in the flow regimes of the gas and liquids flowing inside the column. The flow regime associated with flooding generates more high frequency white noise, which can be detected in the DP signal across the column. This whitepaper has discussed how the Advanced Diagnostics capability available on both the Rosemount 3051S HART transmitter and the 3051S Fieldbus transmitter is able to use this phenomenon to generate an Incipient Flooding alert. When an operator is made aware that the column is approaching flooding, adjustments can be made to prevent the column from becoming completely flooded.

References

1. Nicholas P. Cheremisinoff, Ph.D., "Handbook of Chemical Processing Equipment", Butterworth-Heinemann, Woburn, MA, (2000), p. 163
2. *ibid*, p. 166
3. Norman P. Liebermann, "Troubleshooting Process Operations, 3rd Edition", Pennwell Publishing Co., Tulsa, OK, (1991), pp. 256 – 280

Resources

Rosemount 3051S Series of Instrumentation
<http://www.rosemount.com/3051s>