

Smart Wireless Gateway 1552WU

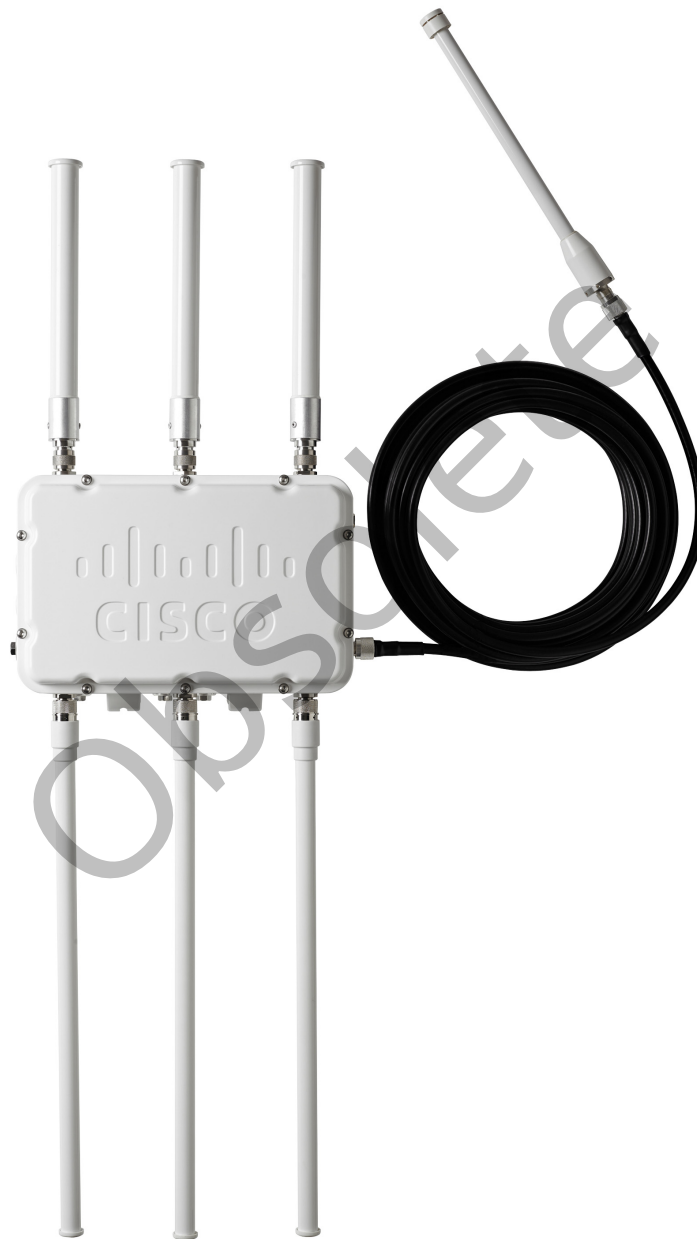

Obsolete

Contents

Section 1: Initial Connection

1.1 Overview	1
1.2 System requirements	2
1.3 Initial setup	2
1.3.1 Prepare PC/laptop.....	2
1.3.2 Configure the gateway	3
1.3.3 System backup	8

Section 2: Software Setup

2.1 Overview	9
2.2 System requirements	9
2.3 Software installation	10
2.4 Security setup utility	10
2.4.1 Setup.....	10
2.5 Licensing and credits.....	11

Section 3: Host Integration

3.1 Overview	13
3.2 Network architecture	13
3.3 General block information	13
3.4 Modbus	14
3.4.1 Communication settings.....	14
3.4.2 Register mapping	17

Section 4: DeltaV Ready

4.1 Overview	21
4.2 Latency considerations in control logic design and operation.....	21
4.3 Requirements	21
4.4 Setup	22

Section 5: Redundancy

5.1 Overview	25
5.2 Requirements	25
5.3 Setup	26
5.4 Mounting and connections	28
5.5 Diagnostics	28
5.6 Gateway replacement	30

Section 6: Wi-Fi Connectivity

6.1 Overview	31
6.2 Wi-Fi architecture	31

Obsolete

Smart Wireless Gateway 1552WU

NOTICE

Read this manual before working with the product. For personal and system safety, and for optimum product performance, make sure you thoroughly understand the contents before installing, using, or maintaining this product.

The United States has two toll-free assistance numbers and one international number.

Customer Central

Technical support, quoting, and order-related questions.

1-800-999-9307 (7:00 am to 7:00 pm CST)

North American Response Center

Equipment service needs.

1-800-654-7768 (24 hours)

International

(952)-906-8888

⚠ CAUTION

The products described in this document are NOT designed for nuclear-qualified applications.

Using non-nuclear qualified products in applications that require nuclear-qualified hardware or products may cause inaccurate readings.

For information on Rosemount nuclear-qualified products, contact your local Emerson Process Management Sales Representative.

Obsolete

Section 1 Initial Connection

⚠ WARNING

Failure to follow these installation guidelines could result in death or serious injury.

- Only qualified personnel should perform the installation.

Explosions could result in death or serious injury.

- Do not remove the connection head cover in explosive atmospheres when the circuit is live.
- Before connecting FOUNDATION™ fieldbus in an explosive atmosphere, make sure the instruments in the loop are installed in accordance with intrinsically safe or non-intrinsic field wiring practices.
- Verify that the operating atmosphere of the transmitter is consistent with the appropriate hazardous locations certifications.
- All connection head covers must be fully engaged to meet explosion-proof requirements.

Process leaks could result in death or serious injury.

- Do not remove the thermowell while in operation.
- Install and tighten thermowells and sensors before applying pressure.

Electrical shock could cause death or serious injury.

- Use extreme caution when making contact with the leads and terminals.

1.1

Overview

This section describes how to connect to the Gateway for the first time and what settings should be configured before placing it on a live control network. It is important to note that some Gateways are used in stand-alone applications and do not reside on a network. In these cases, it is still important to configure the items outlined in this section.

Before the Gateway can be permanently mounted and connected to a live control network, it needs to be configured with an IP address. This is done by forming a private network between the gateway and a PC/Laptop. The following items are needed to complete this section:

- Gateway
- PC/Laptop
- 24 VDC (nominal) power supply

Note

If the Gateway was ordered with the DeltaV™ Ready option, it has been configured to operate on a DeltaV control network, and the Initial Configuration Section does not need to be completed. Only setting the password is required.

1.2 System requirements

The following requirements apply to the PC/Laptop used to configure the Gateway. Additional requirements may apply if using the optional Security Setup Utility or AMS® Wireless Configurator. See [Section 2: Software Setup](#) for more information.

Web browser applications:

- Mozilla Firefox® 1.5 or higher
- Microsoft® Internet Explorer® 6.0 or higher

Ethernet:

- 10/100BaseTX Ethernet communication protocol

1.3 Initial setup

1.3.1 Prepare PC/laptop

The PC/Laptop will need to be configured to form a private network before communicating to the Gateway. The network settings can be found in the control panel of the PC/Laptop. To configure these settings:

1. Find and open the **Control Panel**. (It is generally found from the Start Menu.)
2. Open **Network Connections**.
3. Select **Local Area Connection**.
4. Right click the mouse and select **Properties** from the list.
5. Select **Internet Protocol (TCP/IP)**, and choose the **Properties** button.
6. From the General tab, select Use the following IP address button.
7. Set the IP Address to **192.168.1.12** and press the Tab button.
8. A Subnet mask of **255.255.255.0** should fill in automatically.
9. Select **OK** to close the Internet Protocol (TCP/IP) window.
10. Select **Close** on the Local Area Connection window.

Internet proxies will need to be disabled through the PC/Laptop's default Internet browser.

1. Find and open the default Internet browser (typically Microsoft Internet Explorer).
2. Find the Tools menu and select **Internet Options**.
3. From the Connections tab, select the **LAN Settings** button.
4. Under Proxy Server the boxes for Automatically Detect Settings and Use a proxy server for your LAN should be unchecked.

5. Select **OK** to close the Local Area Network (LAN) Settings window.
6. Select **OK** to close the Internet Options window.

The PC/Laptop is now set up to form a private network and to communicate with the Gateway.

Note

Connecting to the Gateway's secondary Ethernet port will require different network settings. Please see [Table 1-1 on page 1-3](#) for additional network settings

Table 1-1. Default IP Addresses

	Gateway	PC/laptop	Subnet
Ethernet 1	192.168.1.10	192.168.1.12	255.255.255.0
Ethernet 2	192.168.2.10	192.168.2.12	255.255.255.0
Ethernet 1 (DeltaV Ready)	10.5.255.254	10.5.255.200	255.254.0.0
Ethernet 2 (DeltaV Ready)	10.9.255.254	10.9.255.200	255.254.0.0

1.3.2 Configure the gateway

It is now possible to log into the Gateway for the first time and begin configuration for placement on a live control network. The following items need to be configured:

- Security Passwords
- Time Settings
- TCP/IP Network Settings

Use the following procedure to log in to the Gateway:

1. Open a standard web browser (typically Microsoft Internet Explorer).
2. Enter **192.168.1.10** in the address bar.
3. Acknowledge the security to proceed.
4. In the User Name field, enter "**admin**".
5. In the Password field, enter "**default**".

The web browser will now be directed to the Gateway's default home page. There is a navigation menu located on the left hand side with four main areas.

- **Diagnostics:** View status of communications, client server parameters, and more
- **Monitor:** Screens created by the user to view data from field devices
- **Explorer:** Basic view of values from field devices
- **Setup:** Configure the Gateway for operations, security, and host system integration

Security passwords

There are four role based user accounts for the gateway with varying levels of access. The table below describes this access.

Role	User name	Web interface access
Executive	exec	Read-only access
Operator	oper	Read-only access
Maintenance	maint	Configure HART [®] device settings Configure Modbus communications Configure Modbus register mapping Configure OPC browse tree Configure Active Advertising
Administrator	admin	Includes all maintenance privileges Configure Ethernet network settings Configure <i>WirelessHART</i> [®] network settings Set passwords Set time settings Set home page options Configure custom point pages Restart applications

Each of the initial passwords for the user accounts is default. It is recommended, for security purposes, that these passwords are changed. The administrator password should be appropriately noted when changed. If it is lost, please contact Emerson Process Management for technical support.

To change the User Accounts Passwords:

1. Navigate to **System Settings>Users>User Accounts**.
2. Set the new password for each role based user account, and confirm.
3. Select **Submit**.

Note

It is suggested that the default security settings in **System Settings>Users>User Accounts** be changed to the local IT best practices or the “Normal” setting after initial login. Strong or custom settings are available for more robust passwords. For more information on this screen and others please see the User Interface Terminology Guide (00809-0600-4420).

Time settings

The Gateway is the timekeeper for the *WirelessHART* network, so it is imperative that the Gateway's time is accurate for timestamp data to be meaningful. Time settings can be found by navigating to **System Settings>Time**.

There are three ways to set the Gateway time:

1. **Network Time Protocol (recommended).** This option uses a Network Time Protocol (NTP) server to slowly adjust the Gateway's time in order to match the time of the control network. Enter the IP address for the NTP server and select the packet version (1, 2, 3, or 4).
2. **Set with PC Time.** This option will match the Gateway's time to that of the PC/Laptop.
3. **Manual Entry.** This option allows the user to enter a specific date (MM:DD:YY) and time (HH:MM:SS).

Note

Network Time Protocol (NTP) is recommended for the best network performance because it always adjusts time to match the network time server.

Figure 1-1. Time Settings

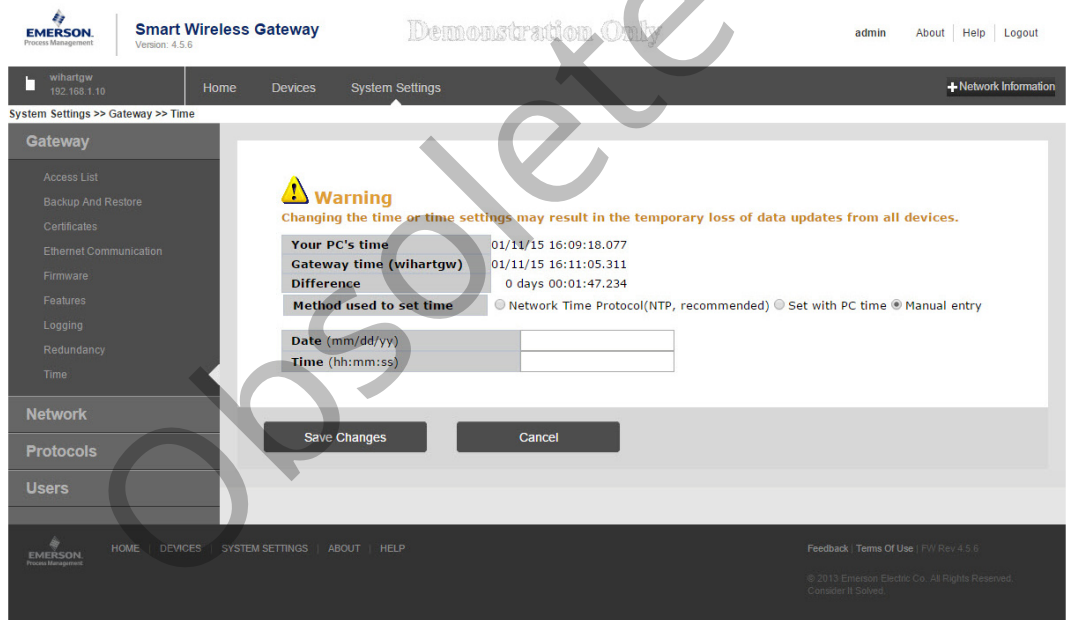

TCP/IP network settings

WARNING

Use caution when making changes to the TCP/IP network settings. If they are lost or improperly configured, it may be impossible to log into the Gateway. Contact the network administrator for information on the proper TCP/IP network settings to apply

Prior to the gateway being installed and connected to a live control network, it should be configured with an IP address, as well as other TCP/IP network settings.

Request the following configuration items from the network administrator:

- Specify an IP address, or use a DHCP server
- Hostname
- Domain Name
- IP address
- Netmask
- Gateway

Obtaining an IP address from a DHCP server is not recommended, since the Gateway operation will be dependent on the availability of the DHCP server. For maximum gateway availability it is best practice to specify an IP address.

To change the TCP/IP Network Settings:

1. Navigate to **System Settings>Gateway>Ethernet Communication** protocol.
2. Select Specify an IP address (recommended).
3. Enter the following:
 - Hostname
 - Domain Name
 - IP Address
 - Netmask
 - Gateway
4. Select **Submit**.
5. When prompted, click **Restart apps**.
6. Select **YES** to confirm restart.
7. Close the web browser.

Note

Once the IP Address of the Gateway has been changed, communications to the web interface will be lost. Restart the web browser, then log back into the Gateway using the new IP address and other TCP/IP network settings. The PC/Laptop TCP/IP network settings may need to be changed.

Figure 1-2. Ethernet Settings

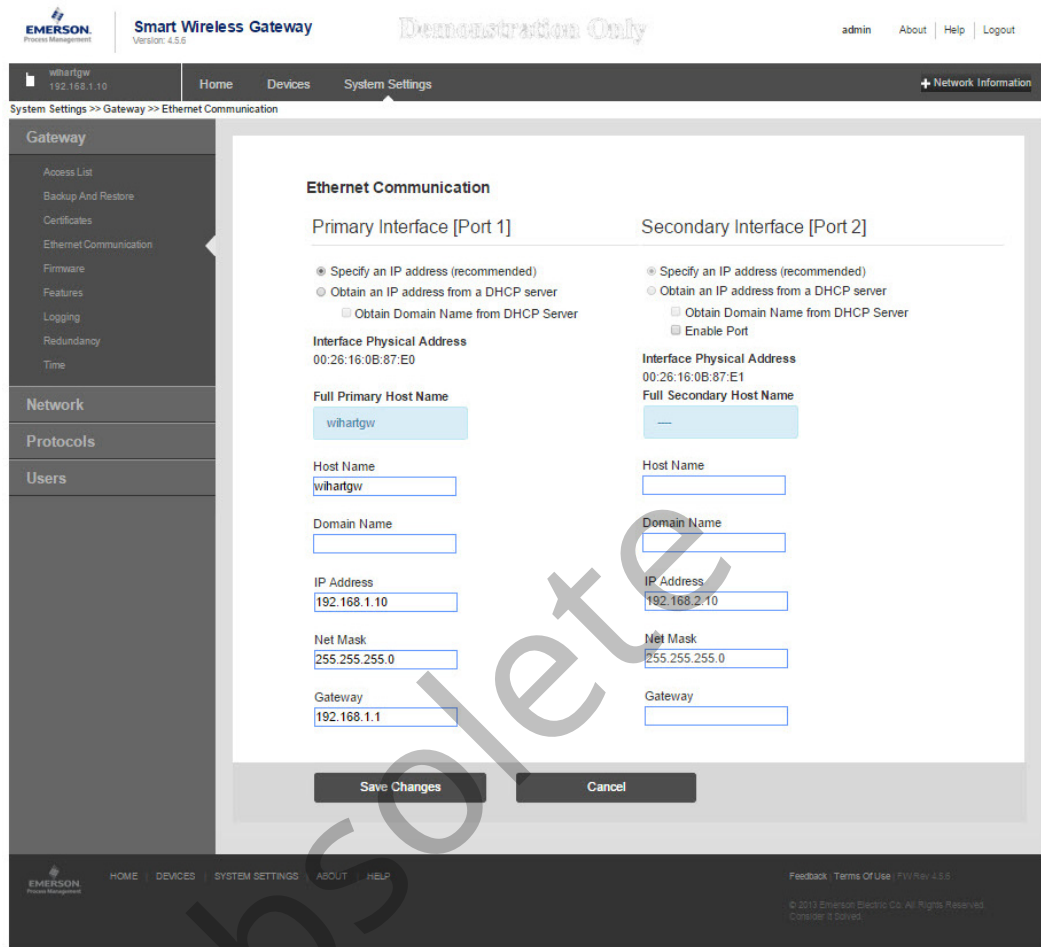

Quality of service

In order to enhance the data traffic from the *WirelessHART* radio to the network the Quality of Service (QoS) option has been included in the Ethernet Protocol page to allow selection of a specific traffic control mechanism based on the various manners increase network performance within a more comprehensive network. There are twenty-one options to choose from (drop-down menu) as listed and described below, these are the Differentiated Services Cope Point (DSCP) codes as a standard embedded into network messages IP header:

- Default: no specific traffic prioritization is selected
- Assured forwarding (AF): this mechanism allows the data traffic to be prioritized based on the required throughput, delay, jitter, loss or latency following an assured forwarding per hop behavior. There are four AF Classes and each class has three drop probabilities which are identified on the bits assignment at the IP header (first 6 bits within Differentiated Services field)

Drop	Class 1	Class 2	Class 3	Class 4
Low	AF 11	AF 21	AF 31	AF 41
Medium	AF 12	AF 22	AF 32	AF 42
High	AF 13	AF 23	AF 33	AF 43

- Class selector (CS): this mechanism allows for a selection of seven options which prioritizes the data packets as per the option bits within the Type of Service (ToS) byte. The combination of all three IP Precedence bits is used to adjust the IP packet prioritization within the network.

P2	P1	P0	T2	T1	T0	CU1	CU0
IP Precedence			Delay, Throughput and Reliability			Currently Unused	
0	0	1	0	0	0	CS 1	
0	1	0	0	0	0	CS 2	
0	1	1	0	0	0	CS 3	
1	0	0	0	0	0	CS 4	
1	0	1	0	0	0	CS 5	
1	1	0	0	0	0	CS 6	
1	1	1	0	0	0	CS 7	

- Expedited forwarding: this mechanism is used when the data traffic is targeted to have low delay, low jitter, low loss and low latency, hence prioritizing bandwidth to target a “point-to-point” communication experience.

The recommended differentiated services setup are: AF41 (Assured Forwarding 41) or EF (Expedited Forwarding). The AF41 shall be used whenever video related data is part of the wireless solution and EF shall be used for any other solution which doesn't include video as part of the package.

1.3.3 System backup

The Gateway has a System Backup and Restore feature that saves all user-configured data. It is best practice that a System Backup be performed periodically throughout the installation and configuration process.

1. Navigate to **System Settings>Gateway>Backup And Restore>Save Backup**.
2. Select **Save Backup**.
3. The Gateway collects the configuration date and when the file download pop up appears, select **Save**.
4. Enter a save location and file name.
5. Select **Save**.
6. Select **Return to form**.

Note

System backup contains user passwords and keys used for encrypting communication. Store downloaded system backups in a secure location.

Section 2 Software Setup

Overview	page 9
System requirements	page 9
Software installation	page 10
Security setup utility	page 10
Licensing and credits	page 11

2.1 Overview

This section discusses the installation and setup of the optional software available for the Smart Wireless Gateway. This software is not required for the wireless field network to operate; however, it will aid in secure host integration as well as wireless field device configuration.

Additional system components may be installed depending on the current configuration of the system.

2.2 System requirements

Table 2-1. PC Hardware

Minimum requirements	Recommended requirements
Intel™ Core 2 Duo, 2.0 GHz	Intel Core 2 Quad, 2.0 GHz or greater
1 GB Memory	3 GB Memory or Greater
1.5 GB free hard disk space	2 GB or more of free hard disk space

Note

Additional hard disk space is required for SNAP-ON™ applications. The minimum monitor requirements are 1024 x 768 resolution and 16-bit color.

Table 2-2. Supported Operating Systems

Operating system	Version
Microsoft® Windows™ XP	Professional, Service Pack 3
Windows Server 2003	Standard, Service Pack 2
Windows Server 2003 R2	Standard, Service Pack 2
Windows Server 2008	Standard, Service Pack 2
Windows Server 2008 R2	Standard, Service Pack 1
Windows 7	Professional, Service Pack 1
Windows 7	Enterprise, Service Pack 1

2.3 Software installation

The software can be obtained from Emerson during solution implementation. Depending on the PC system configuration, installation may take 30-35 minutes. To install the software:

1. Exit/close all Windows programs, including any running in the background, such as virus scan software.
2. Insert Disk 1 into the CD/DVD drive of the PC.
3. Follow the prompts.

Note

If the autorun function is disabled on the PC, or installation does not begin automatically, double click D:\SETUP.EXE (where D is the CD/DVD drive on the PC) and click OK.

2.4 Security setup utility

The Security Setup Utility enables secure communications between the Gateway and host system, asset management software, data historians, or other applications. This is done by encrypting the standard data protocols (AMS[®] Wireless Configurator, Modbus[®] TCP, EtherNet/IP[™], and OPC[™]) used by the Gateway and making them available through various proxies within the Security Setup Utility. These proxies can function as a data server for other applications on the control network. The Security Setup Utility can support multiple Gateways at once and each proxy can support multiple client application connects.

Note

OPC communications requires the use of the Security Setup Utility regardless of whether encryption is required.

2.4.1 Setup

In the Security Setup Utility add a new proxy for each Gateway based on the communication protocol that is being used. For example, add an OPC proxy for each Gateway that is communicating OPC.

Use the following procedure to add a new proxy in the Security Setup Utility:

1. Open the **Security Setup Utility**.
2. Select **EDIT>NEW**, then select the type of new proxy to be added.
3. Right click on the **new proxy entry** and select **Properties**.
4. Enter the target Gateway's Hostname and IP Address.
5. Select **OK**.
6. Select **FILE>SAVE**.
7. When prompted for authentication, enter the admin password for the target Gateway.
8. Select **OK**.
9. Repeat **steps 2-8** to added additional proxies.
10. Select **FILE>EXIT** to close the Security Setup Utility.

During this process the Gateway will exchange security certificates (digital signatures) with the proxy.

Figure 2-1. Security Setup Utility

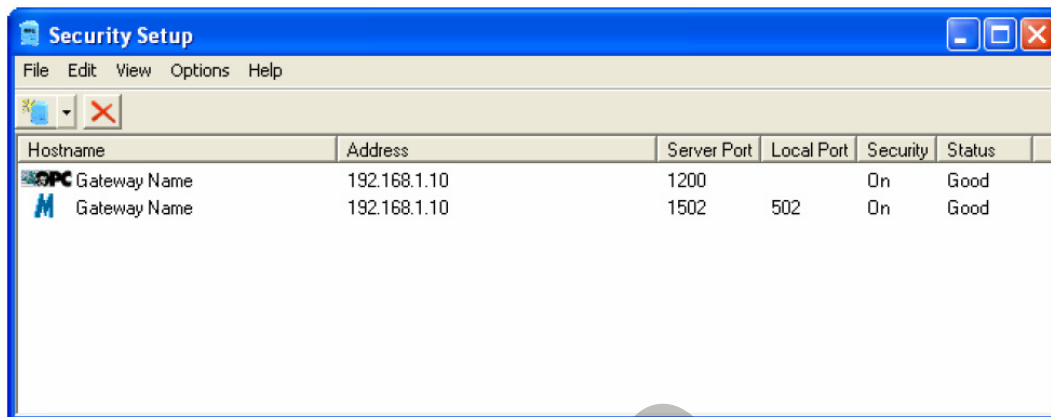

2.5 Licensing and credits

The latest licensing agreements are included on each disk of the software pack.

“This product includes software developed by the OpenSSL Project for use in the OpenSSL Toolkit. (<http://www.openssl.org/>)”

“This product includes software written by Eric Young (eay@cryptsoft.com)”.

Obsolete

Section 3 Host Integration

Overview	page 13
Network architecture	page 13
Internal firewall	page 13
Internal firewall	page 13
Modbus	page 14

3.1 Overview

This section describes how to connect the Gateway to a host system and integrate data gathered from the field device network. It covers network architectures, security, and data mapping.

In accordance with Emerson *WirelessHART*[®] security guidelines, the Emerson Gateway should be connected to the host system via a LAN (Local Area Network) and not a WAN (Wide Area Network).

3.2 Network architecture

Physical connection types are important when determining the network architecture and what protocols can be used for integration. Ethernet is the main physical connection type. Emerson provides all support to design, scope and commission the Smart Wireless Gateway 1552WU into various types of hosts, please contact us for further information on this topic.

Ethernet

An Ethernet connection supports Modbus[®] TCP, OPC[™], AMS[®] Wireless Configurator, EtherNet/IP[™], and HART[®] TCP protocols. Using this connection type, the Gateway is connected directly to a control network using a network switch, router, or even via a wireless backhaul. Often there are two networks for redundancy purposes.

3.3 Internal firewall

The Gateway supports an internal firewall that inspects both incoming and outgoing data packets. TCP ports for communication protocols are user configurable, including user specified port numbers and the ability to disable ports.

The Gateway's internal firewall settings can be found by navigating to **System Settings>Protocols>Protocols and Ports**.

Figure 3-1. Security Protocols Page (Internal Firewall)

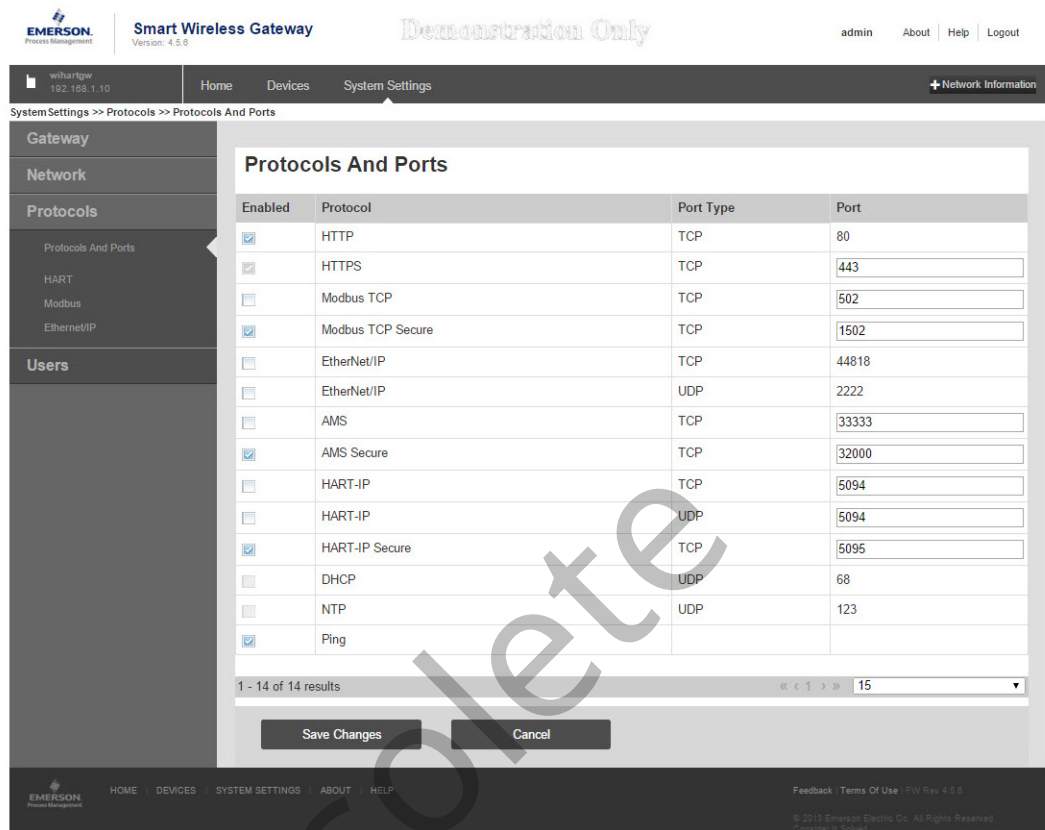

3.4 Modbus

The Gateway supports Modbus TCP over Ethernet. It functions as a sub device on the Modbus network and must be polled by a Modbus master or client (host system).

3.4.1 Communication settings

It is important that the Modbus communication settings in the Gateway match the setting in the Modbus master or client. Please refer to host system documentation for more information on how to configure these settings. The Modbus communication settings can be found by navigating to **System Settings>Protocols>Modbus**.

Figure 3-2. Modbus Communications Page

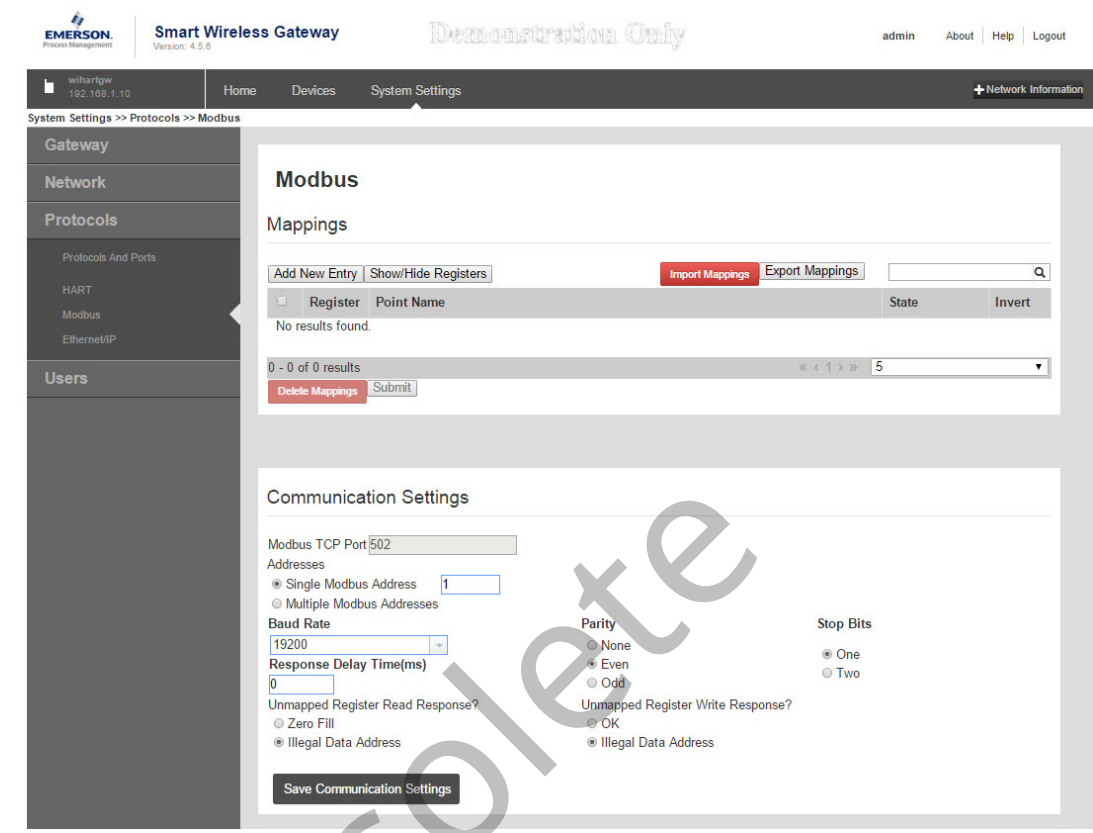

Single Modbus Address: When this option is selected, this address is used by the Gateway for Modbus RTU communications (not applicable to the 1552WU Gateway).

Multiple Modbus Addresses: When this option is selected, a new column for address will appear on the Modbus mapping page.

Modbus TCP Port: This is the TCP/IP port the Gateway uses for Modbus TCP (Ethernet). To change TCP/IP port settings, see the Internal Firewall section for more details.

Baud Rate: The data rate or speed of serial communications. This setting is only required for Modbus RTU (not applicable to the 1552WU Gateway).

Parity: This setting determines parity (none, even, or odd) to use for error checking purposes. This setting is only required for Modbus RTU (not applicable to the 1552WU Gateway).

Stop Bits: This setting determines the number (1 or 2) of stop bits to use when ending a message. This setting is only required for Modbus RTU (not applicable to the 1552WU Gateway).

Response delay time (ms): This setting determines how long (ms) the Gateway waits before responding to a Modbus request. This setting is only required for Modbus RTU (not applicable to the 1552WU Gateway).

Unmapped register read response: This is the value returned by the Gateway if the Modbus master requests a register with no data assigned to it (empty register). It is recommended this be set to zero fill to prevent errors.

Floating point representation: This setting determines if the Gateway uses floating point values or integer values. There are three options for this setting:

- **Float:** This option uses 32 bit floating point values.
- **Round:** This option rounds the data value to the nearest whole number.
- **Scaled:** This option uses scaled integers to offset negative values or increase decimal point resolution. The equation for scaled integers is:

$$y = Ax - (B - 32768)$$

Where:

y = Scaled integer returned by the Gateway

A = Gain for scaled integer value

x = Measured value from wireless field device

B = Offset for scaled integer value

Use swapped floating point format: This setting switches which register is sent first for a floating point value. This setting is only used for floating point values.

Incorporate value's associated status as error: This setting will cause the Gateway to report a predetermined value when a communications or critical diagnostic error is received from the wireless field device. The value is user configurable depending on which floating point representation is chosen. See Value reported for error below.

Value reported for error (floating point): This setting determines what value is reported if the wireless field device reports a failure or stops communicating to the Gateway. This setting is used for floating point values. The choices are *NaN* (not a number), *+Inf* (positive infinity), *-Inf* (negative infinity), or *Other* (user specified).

Value reported for error (rounded and native integer): This setting determines what value is reported if the wireless field device reports a failure or stops communicating to the Gateway. This setting is used for rounded or scaled integers. The choice is a user specified value between -32768 and 65535.

Scaled floating point maximum integer value: This determines the maximum integer value for the purpose scaling integers. 999-65534.

Use global scale gain and offset: This setting determines if a global gain and offset is applied for scaled integers or if each value has a unique gain and offset. Unique gain and offsets are found on the Modbus Mapping page.

Global scale gain: This value is multiplied to the data values for the purpose of scaling integers. If global scaling is not selected, a gain value will be available for each separate data value on the Modbus Mapping page.

Global scale offset: This value is added to the data values for the purpose of scaling integers. If global scaling is not selected, an offset value will be available for each separate data value on the Modbus Mapping page.

3.4.2 Register mapping

Register mapping is the process of assigning data points from wireless field devices to Modbus registers. These registers can then be read by a Modbus master or client. Modbus register mapping can be found by navigating to **System Settings>Protocols>Modbus**.

Figure 3-3. Modbus Register Map Page

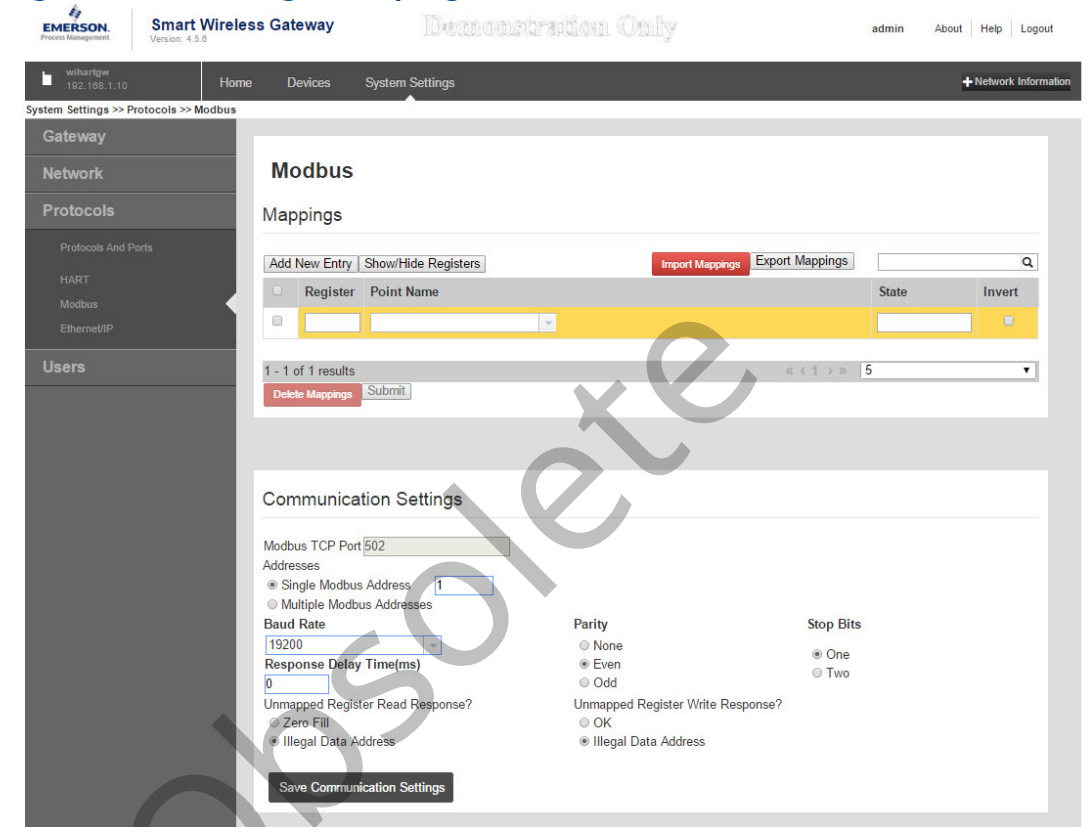

To add a new data point to the Modbus register map:

1. Click **Add New Entry**.
2. Complete all of the table entries for the new data point (note that the entry columns may vary based on the Modbus communications settings).
3. Repeat for each new data point.
4. Click **Submit**.
5. When changes have been accepted, click **Return to form**.

Address: This is the Modbus RTU address used by the Gateway for this data point. It is possible to group data points assigning them the same address (i.e. all data points from the same process unit can have the same address). This column only appears if Multiple Modbus Addresses is selected on the Modbus Communications page.

Register: This is the Modbus register number used for this data value. Modbus registers hold two bytes (16 bits) of information; therefore 32 bit floats and integers require two Modbus

registers. Each data point needs a unique Modbus register number, unless they are assigned different addresses. Register numbers 0-19999 are reserved for Boolean (bit, coil, binary, etc...) values. Register numbers 20000+ are reserved for floating point or integer values.

Point Name: This is a two part name for the data point. The first part is the HART Tag of the wireless field device which is producing the data. The second part is the parameter of the wireless field device.

Point Name is entered as <HART Tag.PARAMETER>. Point Name can be entered using the list of values (...) or manually entered. The following table gives a list of standard device parameters which may be considered for Modbus register mapping.

Table 3-1. Standard Device Parameters for Modbus Register Mapping

Parameter	Description	Data type
PV	Primary Variable	32-bit float
SV	Secondary Variable	32-bit float
TV	Tertiary Variable	32-bit float
QV	Tertiary Variable	32-bit float
RELIABILITY	A measure of connectivity to the Gateway	32-bit float
ONLINE	Wireless communications status	Boolean
PV_HEALTHY	Health status for PV	Boolean
SV_HEALTHY	Health status for SV	Boolean
TV_HEALTHY	Health status for TV	Boolean
QV_HEALTHY	Health status for QV	Boolean

PV, SV, TV, and QV (dynamic variables) will vary by device type. Please refer to the device's documentation for more information on what value is represented by each dynamic variable.

RELIABILITY and ONLINE relate to wireless communications. RELIABILITY is the percentage of messages received from the wireless field device. ONLINE is a true/false indication of whether the device is communicating on the wireless network.

_HEALTHY parameters are a true/false indication of the health of a particular variable (= dynamic variable - PV, SV, etc...). These parameters incorporate critical diagnostics from the wireless field device as well as communication status.

Note

The **_HEALTHY parameters are a great indication of the health and communications status of the data values.

State (state value): The value of a data point which drives a Modbus output of 1. For example, if a data point is reported as either True or False, a state value of True will report a 1 for True and 0 for False. A state of False will report a 0 for True and a 1 for False. State is only required for register numbers 0-19999 (Boolean, bit, coil, binary, etc...).

Invert: This check box will invert the Modbus output from a 1 to a 0 or a 0 to a 1. Invert is only used for Boolean values using register numbers 0-19999.

Gain: This value is multiplied to the data value for the purpose of scaling integers. Gain is only required if scaled is chosen on the Modbus communications page and globe gain and offset is not chosen.

Offset: This value is added to the data value for the purpose of scaling integers. Offset is only required if scaled is chosen on the Modbus communications page and globe gain and offset is not chosen.

Predefined Modbus registers

In addition to user configurable parameters, the Gateway also supports a list of predefined Modbus registers with diagnostics and test parameters. The following table is a list of the predefined Modbus registers.

Table 3-2. Predefined Modbus Registers with Diagnostics and Test Parameters

Description	Register	Data type
Current Year (1)	49001	32-bit int
Current Month (1)	49002	32-bit int
Current Day (1)	49003	32-bit int
Current Hour (1)	49004	32-bit int
Current Minute (1)	49005	32-bit int
Current Second (1)	49006	32-bit int
Messages Received	49007	32-bit int
Corrupt Messages Received	49008	32-bit int
Messages Sent With Exception	49009	32-bit int
Messages Sent Count	49010	32-bit int
Valid Messages Ignored	49011	32-bit int
Constant Float 12345.0	49012	32 float
SYSTEM_DIAG.HART_DEVICES	49014	32-bit int
SYSTEM_DIAG.ADDITIONAL_STATUS_0	49015	8-bit unsigned int
SYSTEM_DIAG.ADDITIONAL_STATUS_1	49016	8-bit unsigned int
SYSTEM_DIAG.ADDITIONAL_STATUS_2	49017	8-bit unsigned int
SYSTEM_DIAG.ADDITIONAL_STATUS_3	49018	8-bit unsigned int
SYSTEM_DIAG.ADDITIONAL_STATUS_4	49019	8-bit unsigned int
SYSTEM_DIAG.ADDITIONAL_STATUS_5	49020	8-bit unsigned int
SYSTEM_DIAG.ADDITIONAL_STATUS_6	49021	8-bit unsigned int
SYSTEM_DIAG.ADDITIONAL_STATUS_7	49022	8-bit unsigned int
SYSTEM_DIAG.ADDITIONAL_STATUS_8	49023	8-bit unsigned int
SYSTEM_DIAG.ADDITIONAL_STATUS_9	49024	8-bit unsigned int
SYSTEM_DIAG.ADDITIONAL_STATUS_10	49025	8-bit unsigned int
SYSTEM_DIAG.ADDITIONAL_STATUS_11	49026	8-bit unsigned int
SYSTEM_DIAG.ADDITIONAL_STATUS_12	49027	8-bit unsigned int
SYSTEM_DIAG.UNREACHABLE	49028	32-bit int
SYSTEM_DIAG.UPTIME	49029	32-bit int
SYSTEM_DIAG.TEST_BOOLEAN	49031	Boolean
SYSTEM_DIAG.TEST_BYTE	49032	8-bit int
SYSTEM_DIAG.TEST_UNSIGNED_BYTE	49033	8-bit unsigned int
SYSTEM_DIAG.TEST_SHORT	49034	16-bit int
SYSTEM_DIAG.TEST_UNSIGNED_SHORT	49035	16-bit unsigned int
SYSTEM_DIAG.TEST_INT	49036	32-bit int
SYSTEM_DIAG.TEST_UNSIGNED_INT	49038	32-bit unsigned int
SYSTEM_DIAG.TEST_FLOAT	49040	32-bit float

Obsolete

Section 4 DeltaV™ Ready

Overview	page 21
Latency considerations in control logic design and operation	page 21
Requirements	page 21
Setup	page 22

4.1 Overview

Native integration with DeltaV enables the Smart Wireless Gateway to be auto-sensed and easily commissioned for seamless integration with all DeltaV applications: Explorer, Diagnostics, and Control Studio. *WirelessHART*® devices can be easily added to the wireless field network and then reconciled through DeltaV Explorer and assigned to analog channels through drag and drop assignment.

4.2 Latency considerations in control logic design and operation

Since the DeltaV wireless I/O scanner software requests updates for 1/5 of the devices each second, DeltaV receives updates on a particular field device once every 5 seconds. That is not necessarily synchronized with the update rate of the field device. Also, there is some latency between when the field device takes a process sample and when it is permitted to pass its value onto the wireless network. Status update responses can also increase latency in some instances.

So for example, if a device updates once every 8 seconds, and wireless network latency is 2 seconds, the amount of time that could pass between when an event occurred in the field and before it is available to the DeltaV I/O bus is between zero and 15 (8+2+5) seconds. The update period of the DeltaV control module should be added to that total to determine the range of latencies before an event in the field can be acted upon by the control system.

Operators should be made aware that the update rate of wireless measurements on operator screens are somewhat slower than those from wired devices. For example, if the operator initiates a valve movement, it can be 5-15 seconds before confirming feedback appears on the operator screen. Any control logic designed along the same principles should also take the update rates and latencies into account as well.

4.3 Requirements

DeltaV

Version 10.3 or newer.

Smart Wireless Gateway

DeltaV Ready option

4.4 Setup

Out of the box the Smart Wireless Gateway is pre-configured for use on the DeltaV control network. In the DeltaV Explore application, the Gateway will automatically appear in the Decommissioned Nodes folder.

To setup a wireless network will require 3 steps:

1. Commission the Gateway.
2. Assign wireless device tags.
3. Assign Gateway to controller and download.

Figure 4-1. Decommissioned Nodes Folder within DeltaV Explorer

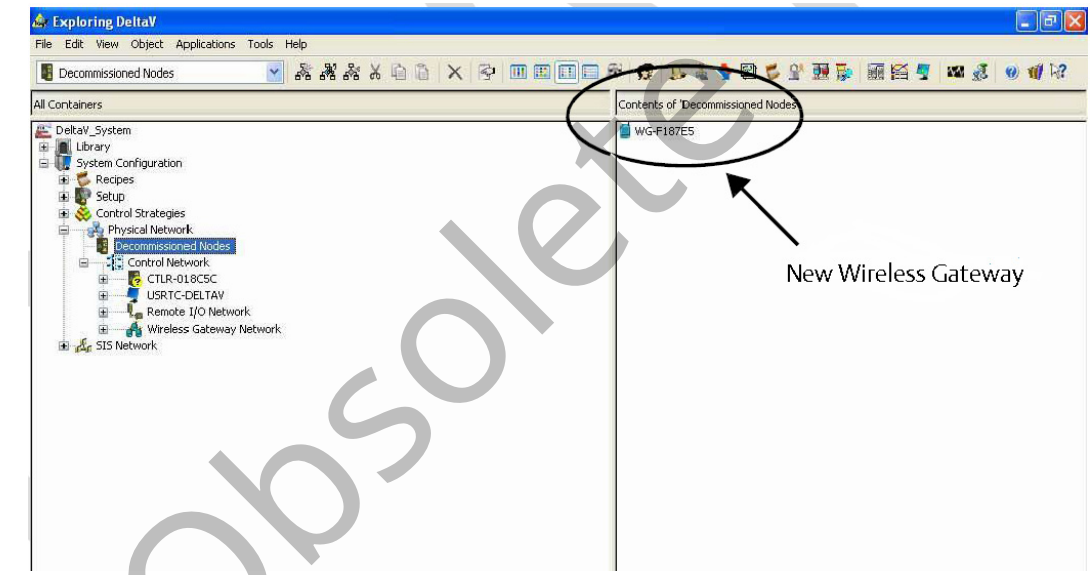

Commission the Gateway using the following procedure:

1. Select **START>PROGRAMS>DELTAV>ENGINEERING> DELTAV EXPLORE** to launch the DeltaV Explorer application.
2. Expand the folder **SYSTEM CONFIGURATION >PHYSICAL NETWORK>DECOMMISSIONED NODES**.
3. Right click on the **Smart Wireless Gateway** and select **Commission**.
4. Enter a name for the Gateway and select **OK**.
5. Select **YES** when prompted to **Auto-Sense Wireless Gateway**.

At this time the **Reconcile I/O** window will appear. The purpose of this screen is to assign *WirelessHART* devices to DeltaV I/O channel. This allows the wireless device to be referenced in other DeltaV applications like Control Studio.

Figure 4-2. Assign WirelessHART Devices to DeltaV I/O Channel

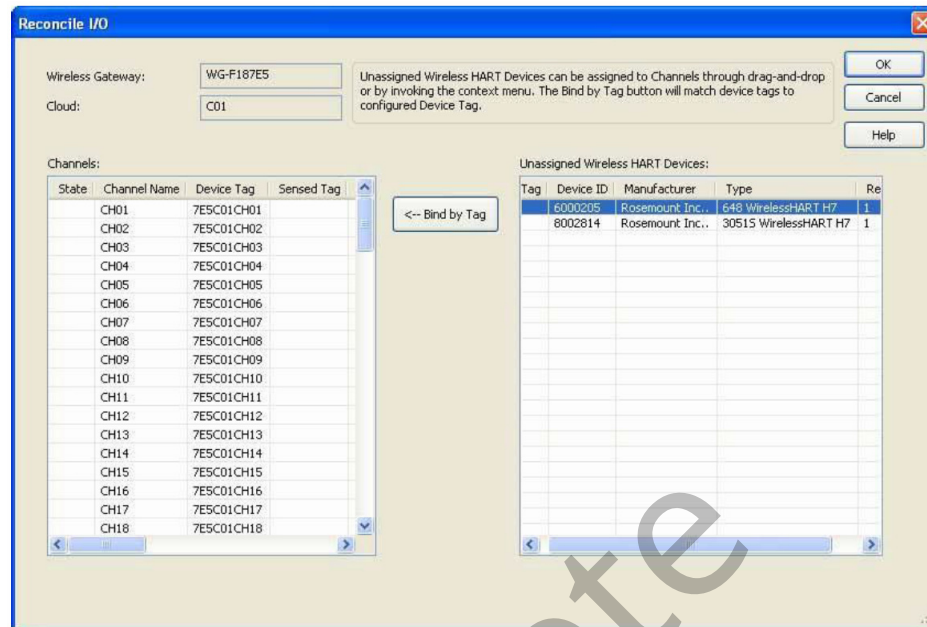

Assign wireless device tags using the following procedure:

1. Drag and Drop *WirelessHART* device from the **Unassigned Wireless HART Devices: list** to the **Channels: list**.
2. Repeat this process for each wireless device until all have been assigned.
3. Select **OK** to continue.

Next the Gateway will need to be assigned to a DeltaV Controller and download all. Assign and download the Gateway using the following procedure:

1. Right click on the **Gateway** and select **Assign...**
2. Use the browse window and select the desired controller.
3. Select **OK** to close the assignment window.
4. Right click on the **Gateway** and select **Download**.
5. Follow the download dialog.
6. Select **OK** to close the download window.

Figure 4-3. Gateway Context Menu (Right Click)

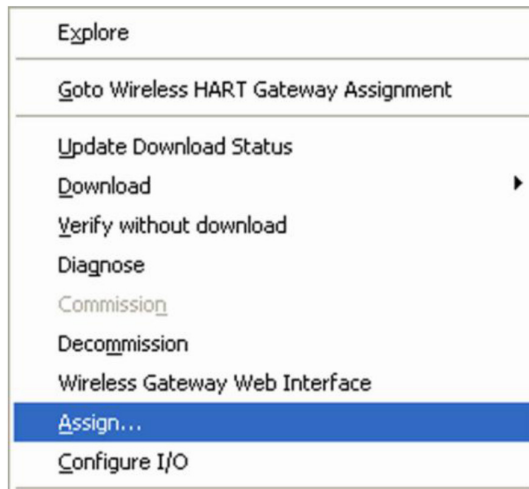

Now the Gateway and wireless devices are fully commissioned and available to use in other DeltaV applications. When new devices are added to the wireless network, they will need to be assigned to DeltaV channels through the reconcile process (right click on Gateway and select configure IO).

Note

Logging in to the Gateway is not possible using the default TCP/IP network setting. If the Gateway is decommissioned, use an IP address 10.5.255.254. If the Gateway is commissioned, right click on the Gateway in DeltaV Explore and select Wireless Gateway Web Interface.

Section 5 Redundancy

Overview	page 25
Requirements	page 25
Setup	page 26
Mounting and connections	page 28
Diagnostics	page 28
Gateway replacement	page 30

5.1 Overview

Redundancy for the Smart Wireless Gateway increases the availability of the wireless field network by providing two sets of physical hardware which operate as a single Gateway system.

This section covers setup and installation of a redundant Gateway system. It also covers diagnostics and integration to help monitor the health of the redundant Gateway system.

- Where to mount the respective antennas
- Illustration of maximum redundancy including dual switch and UPS
- Understanding how the failover works and experience to expect
- How to leverage the multi-master capability for Modbus integrations

5.2 Requirements

Smart Wireless Gateway

Firmware Version 4.4.30 or greater is recommended

RD option for Gateway Redundancy

Static IP Address

Must have matching output protocols (e.g. Modbus[®] or OPC[™]) on each Gateway.

The Redundancy feature is not supported by Wireless Gateways with the DeltaV[™] Ready feature enabled.

Host system

Ethernet connection for Modbus TCP or OPC DA communications

5.3 Setup

When configuring redundant Smart Wireless Gateways, it is only necessary to configure one system. The other Gateway will be configured automatically when it is paired with the first Gateway.

Choose one Gateway as the starter Gateway. For the purposes of this document, it will be referred to as Gateway A. The other Gateway will be referred to as Gateway B. To configure redundancy system settings:

1. Connect a PC/laptop to the Ethernet 1 port on Gateway A.
2. Log in using the admin user account.
3. Navigate to **System Settings>Gateway>Redundancy**.
4. Gateway A's factory serial number will be assigned to Gateway A.
5. Gateway B's factory serial number will be assigned to Gateway B.

The Gateway names will be used in diagnostic messages and host system integration to help identify each Gateway. It is recommended that these names be marked on each physical Gateway, in addition to the configuration settings.

Selecting left or right for Gateway A is for visualization purposes only. It has no effect on performance or functionality.

Figure 5-1. Redundancy System Settings (Setup>Redundancy)

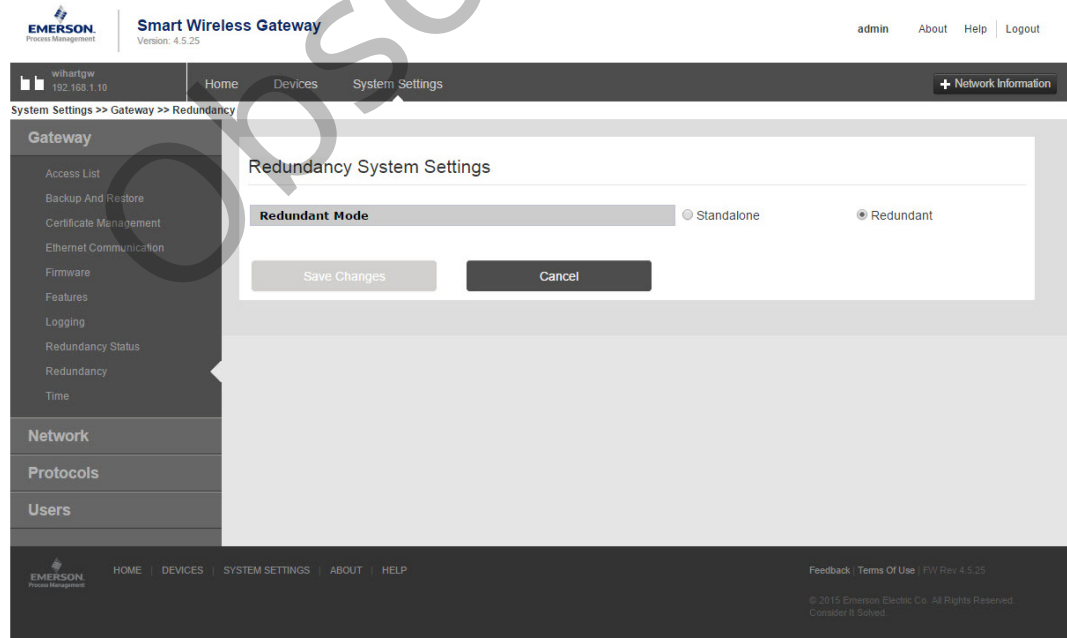

After the redundancy system settings have been configured, the two Gateways must be connected and undergo a pairing process.

To pair both Gateways and form a redundant system:

1. Connect a PC/laptop to the primary Ethernet port on Gateway A.
2. Log in using the admin user account.
3. Navigate to **Diagnostics>Advanced>Redundancy Status**.
4. Connect the secondary Ethernet port on Gateway A to the secondary Ethernet port on Gateway B (see [Figure 5-2 on page 27](#), Redundancy Setup Connections).
5. A dialog will appear on the page, select **Form redundant pair**.
6. Wait for the Pairing to redundant peer status to turn green.
7. Select **Return to page**.

Figure 5-2. Redundancy Setup Connections

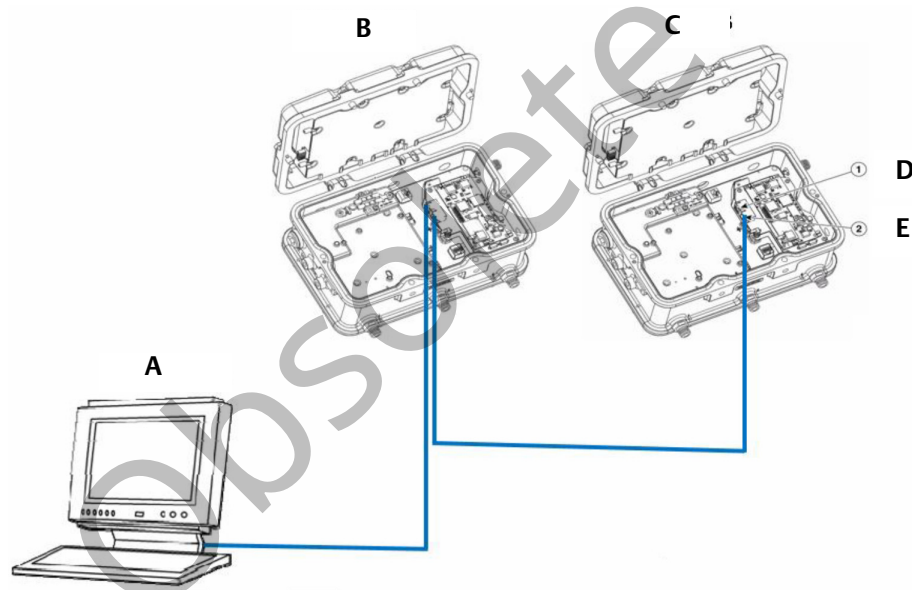

- | | |
|--------------|-----------------------|
| A. PC/laptop | D. Primary Ethernet |
| B. Gateway A | E. Secondary Ethernet |
| C. Gateway B | |

Once the Gateways have finished the pairing process, Gateway A will appear as the current active Gateway on the left hand side and Gateway B will be the standby Gateway on the right (note that left/right hand appearance can be changed on the Redundancy System Settings page). If significant configuration changes need to be downloaded to the standby Gateway, it may temporarily go offline shortly after the pair process is complete. This is expected behavior and does not represent instability in the system.

5.4 Mounting and connections

Redundant Gateways follow similar mounting and connection practices as a standalone Gateway. Refer to [Section 3: Host Integration](#) for more information. In addition to the standard practices, the following considerations should be taken when installing redundant Gateways.

Mounting

The redundant Gateways should be mounted in a location that allows convenient access to the process control network as well and provides good coverage for the wireless field network.

The redundant Gateway antennas should be mounted at the same height and be spaced between 3 ft to 9 ft (1m to 3m) horizontally. This is to ensure that they provide identical coverage for the wireless field network and to help eliminate coverage gap in the event of a switch over.

Ethernet

An Ethernet connection to the host system will support Modbus TCP, OPC, AMS Wireless Configurator, and HART IP protocols. When using this architecture, connect the secondary Ethernet port on Gateway A directly to the secondary Ethernet port on Gateway B. Then connect the primary Ethernet ports for both Gateways to a process control network using separate/redundant network switches.

Note

The primary Ethernet port for each Gateway should be connected to separate network switches on the same process control network. Consult a control system administrator for more details about available redundant network switches.

Power

Power for the redundant Gateways should be applied after all primary and secondary Ethernet and RS-485 connections have been made. Using separate uninterruptable power supplies (UPS) is recommended to ensure availability of the redundant Gateway system.

5.5 Diagnostics

The redundant system will perform many diagnostic checks to verify the health and connectivity of the system. This diagnostics information can be found by navigating to **System Settings>Gateway>Redundancy Status**.

Figure 5-3. Redundancy Status (System Settings>Gateway>Redundancy Status)

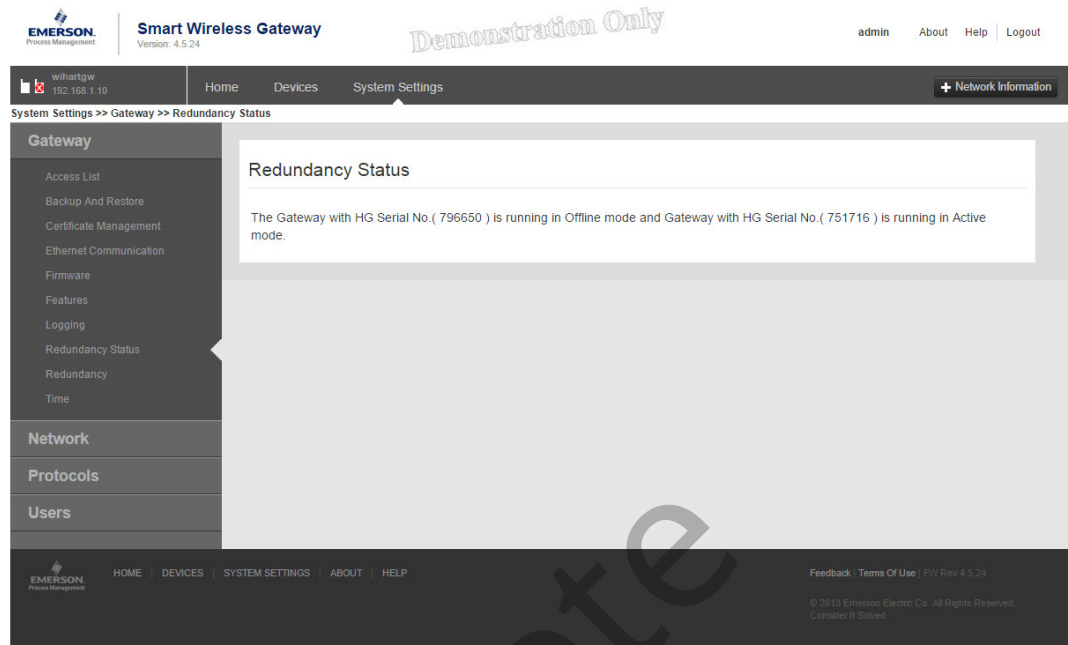

These diagnostics can also be mapped to Modbus registers or OPC tags. The following table covers what diagnostics are included on the Redundancy Status page as well as how they can be mapped as parameters in Modbus or OPC.

Table 5-1. Redundancy Diagnostics

Parameter	Description	Data type
REDUNDANT_HEALTHY	Overall redundancy status indicating the system is ready for a switch-over	Boolean
RF_COVERAGE_FAILURE	Check to verify that both Gateways have the same RF coverage of the wireless field network	Boolean
REDUNDANT_A_ONLINE	Operational status of Gateway A	Boolean
REDUNDANT_A_MASTER	Indication if Gateway A is the active System	Boolean
REDUNDANT_A_PING	Indication if Gateway A is able to ping designated host IP address	Boolean
REDUNDANT_A_ETH0	Electrical connection status of the primary Ethernet port for Gateway A	8-bit unsigned int
REDUNDANT_B_ONLINE	Operational status of Gateway B	Boolean
REDUNDANT_B_MASTER	Indication if Gateway B is the active system	Boolean
REDUNDANT_B_PING	Indication if Gateway B is able to ping designated host IP address	Boolean
REDUNDANT_B_ETH0	Electrical connection status of the primary Ethernet port for Gateway A	8-bit unsigned int

In addition to the redundancy diagnostics, an additional check may be configured to test network connectivity to a host system or other application. The redundant system will use this check to determine the best connectivity option and which Gateway should be set to the active Gateway.

To configure network connectivity check:

1. Navigate to **System Settings>Gateway>Ethernet Communication**.
2. Enter the host system IP address in the **Check Network Connectivity IP Address** field.
3. Select **Submit**.

Figure 5-4. Network Connectivity Check (System Settings>Gateway>Ethernet Communication)

The screenshot displays the 'Ethernet Communication' configuration page in the Smart Wireless Gateway web interface. The page title is 'Ethernet Communication' and it is part of the 'System Settings >> Gateway >> Ethernet Communication' path. The interface includes a sidebar with navigation options like 'Access List', 'Backup And Restore', 'Certificate Management', 'Ethernet Communication', 'Firmware', 'Features', 'Logging', 'Redundancy Status', 'Redundancy', and 'Time'. The main content area contains the following fields:

- System Address
- Host Name: whardgw
- IP Address: 192.168.1.10
- Net Mask: 255.255.255.0
- Gateway: 192.168.1.1
- Check Network Connectivity IP Address: (highlighted field)

At the bottom of the form, there are 'Save Changes' and 'Cancel' buttons. The footer of the page includes the Emerson logo, navigation links (HOME, DEVICES, SYSTEM SETTINGS, ABOUT, HELP), and copyright information: '© 2015 Emerson Electric Co. All Rights Reserved. Controller II Software'.

5.6 Gateway replacement

When replacing or reintroducing a Gateway in a redundant system, always connect both the primary and secondary Ethernet connections before powering the standby Gateway. If the Gateway is being reintroduced (i.e. it was a part of the original redundant system), it will automatically rejoin the redundant system. If the Gateway is new or has been set to default configuration, it will need to be paired to the current active Gateway. Navigate to **System Settings>Gateway>Redundancy** and follow the recommended actions on that page or follow the procedure above to pair Gateways and form a redundant system.

Section 6 Wi-Fi Connectivity

Overview	page 31
Wi-Fi architecture	page 31

6.1 Overview

The Smart Wireless Gateway 1552WU also handles Wi-Fi connections based on IEEE802.11 standard, and it has two radios for this specific connectivity:

- 2.4GHz radio with three external antennas dedicated for local connection to client units which are designed to run each of the various Wi-Fi solutions described on the Wireless Plant Network solutions portfolio
- 5GHz radio with also three external antennas dedicated for the wireless backhaul.

This section presents an overview of this connectivity for proper usage. It's important to emphasize that professional services from Emerson or its Local Business Partner are required to scope, design and commission the solution.

6.2 Wi-Fi architecture

The Smart Wireless Gateway 1552WU must be installed as per the recommendations described on the Cisco Aironet 1550 Series for Hazardous Locations Installation Guide.

The 1552WU can be configured as a Root Access Point (RAP) as well as a Mesh Access Point (MAP). These two roles basically describe the Wi-Fi access point behavior considering a network with several units:

- The RAP is normally the first access point of the network and is hardwired (Ethernet RJ45 port) to the physical network, it can also be a minimum setup for a hot-spot architecture where the access points won't communicate to each other, but simply provide a local Wi-Fi coverage for clients accessing the physical network
- The MAP role is designed to interconnect multiple access points following a mesh type topology enhancing the backhaul capabilities.

For all conditions the 1552WU will always require a Wireless LAN Controller (WLC) which is the responsible to control the Wi-Fi network including routes, data traffic, transmit power control, etc. whereas the WLC is a mandatory requirement for any 1552WU installation. The Figure 6-1 is a sample architecture that shows all various connections we can have considering the WLC, MAP & RAP roles for the access points, and also highlighting the mix of Smart Wireless Gateway 1552WU and Cisco 1550 Series access points.

Figure 6-1. Sample Wireless Architecture Showing Possible Connections

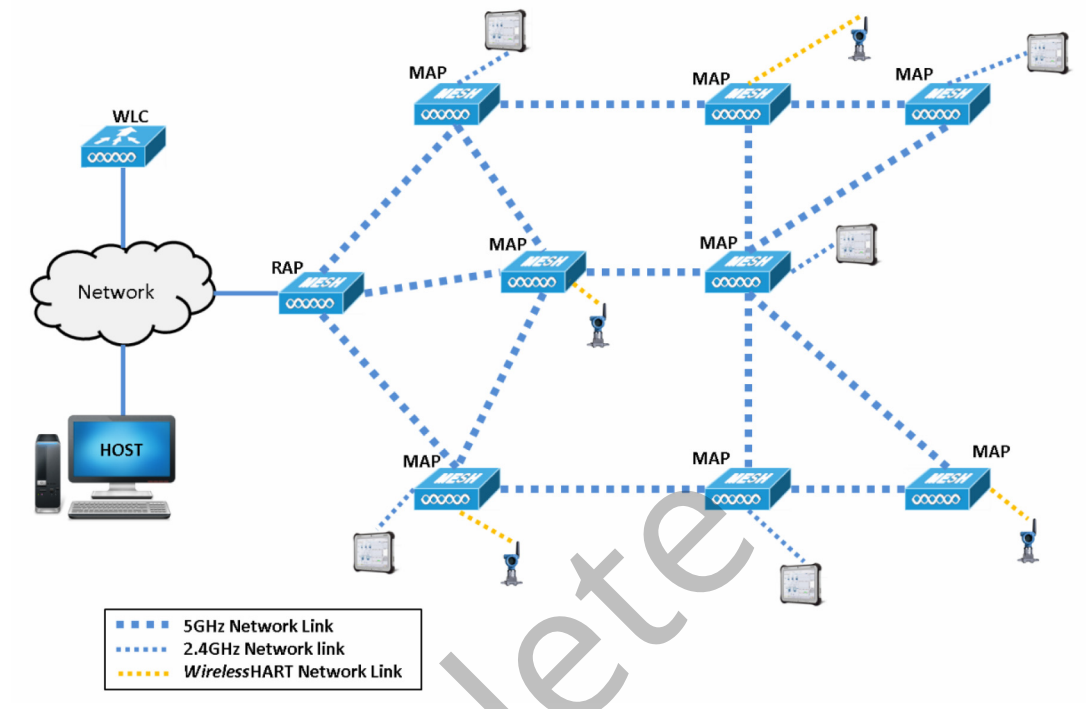

The Wireless LAN Controller is also chosen and setup based on the number of access points included in the final architecture. The architecture is scalable and is completely controlled by the WLC. Other network equipment can be included in the architecture to add security (e.g.: firewalls) or even extra connectivity on the physical network (network switches, etc.).



Please contact your local Emerson contact for more information on the design of Wi-Fi solutions.

Obsolete

Rosemount World Headquarters

Emerson Process Management



6021 Innovation Blvd
Shakopee, MN 55379, USA

-  +1 800 999 9307 or +1 952 906 8888
-  +1 952 949 7001
-  RFQ.RMD-RCC@EmersonProcess.com

North America Regional Office

Emerson Process Management



8200 Market Blvd.
Chanhassen, MN 55317, USA

-  +1 800 999 9307 or +1 952 906 8888
-  +1 952 949 7001
-  RMT-NA.RCCRFQ@Emerson.com

Latin America Regional Office

Emerson Process Management



1300 Concord Terrace, Suite 400
Sunrise, Florida, 33323, USA

-  +1 954 846 5030
-  +1 954 846 5121
-  RFQ.RMD-RCC@EmersonProcess.com

Europe Regional Office

Emerson Process Management Europe GmbH



Neuhofstrasse 19a P.O. Box 1046
CH 6340 Baar
Switzerland

-  +41 (0) 41 768 6111
-  +41 (0) 41 768 6300
-  RFQ.RMD-RCC@EmersonProcess.com

Asia Pacific Regional Office

Emerson Process Management Asia Pacific Pte Ltd



1 Pandan Crescent
Singapore 128461

-  +65 6777 8211
-  +65 6777 0947
-  Enquiries@AP.EmersonProcess.com

Middle East and Africa Regional Office

Emerson Process Management

Emerson FZE P.O. Box 17033,
Jebel Ali Free Zone - South 2
Dubai, United Arab Emirates

-  +971 4 8118100
-  +971 4 8865465
-  RFQ.RMTMEA@Emerson.com

Standard Terms and Conditions of Sale can be found at www.rosemount.com/terms_of_sale.

AMS, and the Emerson logo are registered trademarks and/or service marks of Emerson Electric Co.

DeltaV and SNAP-ON are trademarks of Emerson Electrical Co.

Rosemount and the Rosemount logotype are registered trademarks of Rosemount Inc.

FOUNDATION fieldbus, HART and *WirelessHART* are registered trademarks of FieldComm Group.

Microsoft is a registered trademark of Microsoft Corporation in the United States and other countries.

Modbus is a registered trademark of Modicon, Inc.

Mozilla Firefox is a registered trademark of The Mozilla Foundation.

EtherNet/IP is a trademark of ControlNet International under license by ODVA.

Intel is a trademark of Intel Corporation in the U.S. and/or other countries.

Windows is a trademark of Microsoft Corporation in the United States and other countries.

All other marks are the property of their respective owners.

© 2015 Rosemount, Inc. All rights reserved.