



CLARKSON SEVERE SERVICE KNIFE GATE VALVES

MODEL KS1

The KS1 is a true bi-directional, zero-leakage ASME Class 150 knife gate valve designed for the rigors of severe service applications



FEATURES

- True bi-directional flow and zero leakage shut-off; can be installed in either direction
- Heavy cross section precision-molded elastomer seat provides more surface area for superior isolation
- Field-adjustable, patented gate edge seal system prevents leakage through top of valve
- Enclosed body design prevents any leakage to the outside environment
- Full round port and seat design offers low pressure drop across valve and longer service life in abrasive applications
- Standard inlet and outlet replaceable, rotatable Ni-Resist wear rings extend service life
- Modular frame design allows for installation of any standard accessory without modification
- Fully piggable
- Available in raised or flat face

NOTE

All valves hydrotested per MSS SP-151 and will meet zero leakage isolation from zero to 1.1x Maximum Allowable Working Pressure (MAWP).

GENERAL APPLICATION

The KS1 has many features designed to improve service life and lower cost of ownership. It is suitable for a wide range of severe service slurry applications in:

- Mining and mineral processing
- Oil Sands processing
- Pulp and paper plants
- Coal preparation plants
- Power plants
- Steel processing plants

TECHNICAL DATA

Size range:	NPS 2 - 30 (DN 50 - 750)
Temperature rating:	NR 175 °F (80 °C) EPDM 300 °F (150 °C) HNBR 300 °F (150 °C) FKM 400 °F (205 °C)
Pressure rating:	ASME Class 150
Compliance to:	MSS SP-135 ASME B31.3
Face to face:	MSS SP-135 Short
Flange drillings:	ASME 150 AS 2129 Table D/E PN 10/16/20 SANS T1600

CLARKSON SEVERE SERVICE KNIFE GATE VALVES

MODEL KS1

VALVE BENEFITS

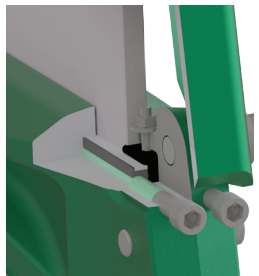
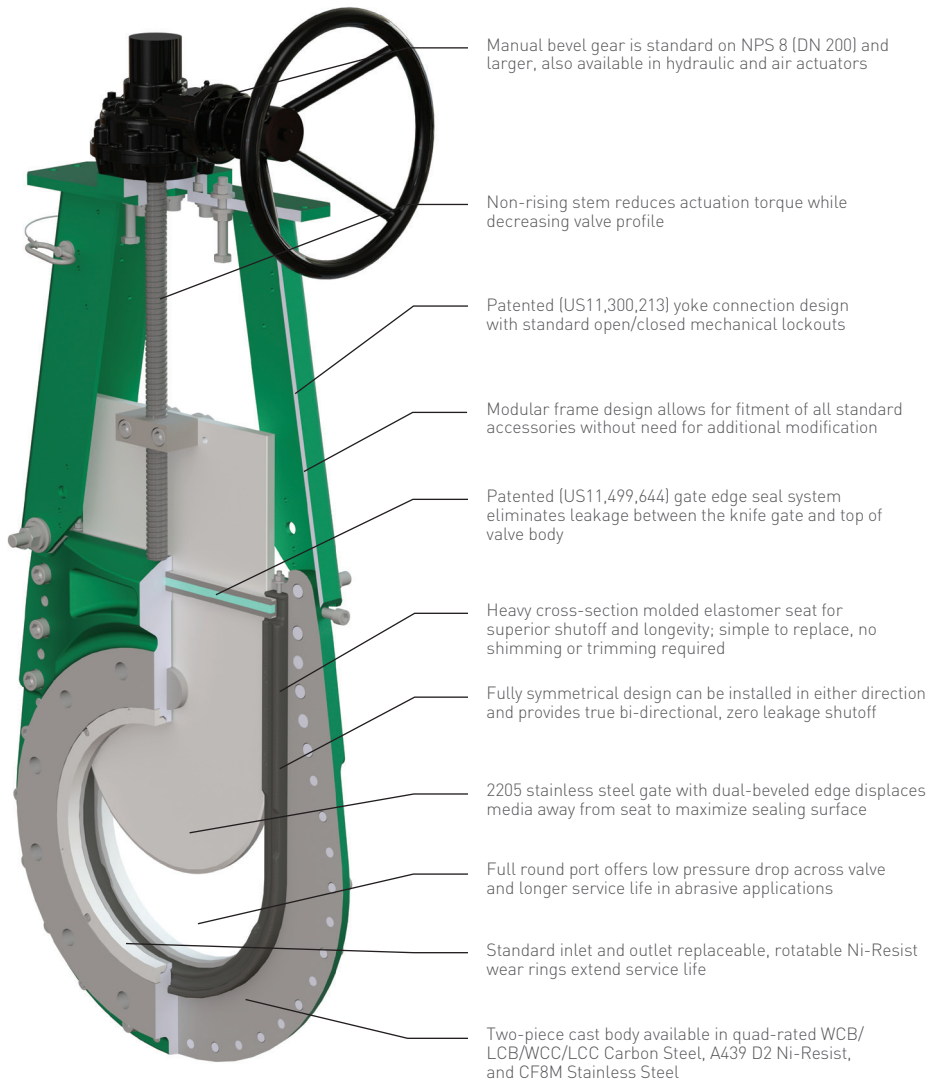

Patented gate edge seal interlocks with transverse seal and scrapers to provide a continuous seal around gate, incorporating benefits of adjustments to packing pressure while valve is in service

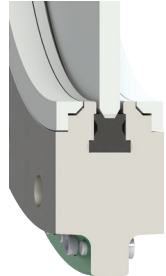

Robust, heavy cross-section seat provides superior isolation performance over the life of the valve, delivering higher cycle life at zero leakage compared to O-ring designs

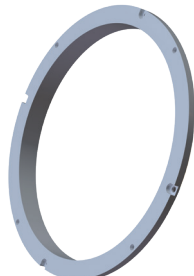

Replaceable and rotatable wear rings reduce wear to the valve body and prolong service life. Rings can be rotated three times through four positions before requiring replacement

Turbulence kinetic energy

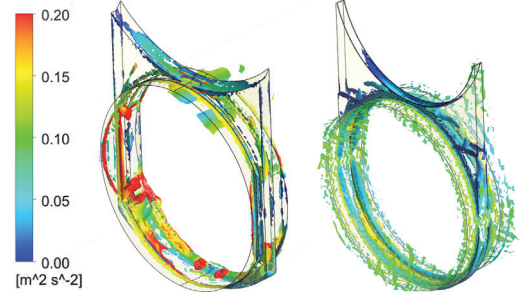

Full round port minimizes any disruption to flow compared to non-round ports, resulting in reduced wear on the valve and downstream components

CLARKSON SEVERE SERVICE KNIFE GATE VALVES

MODEL KS1

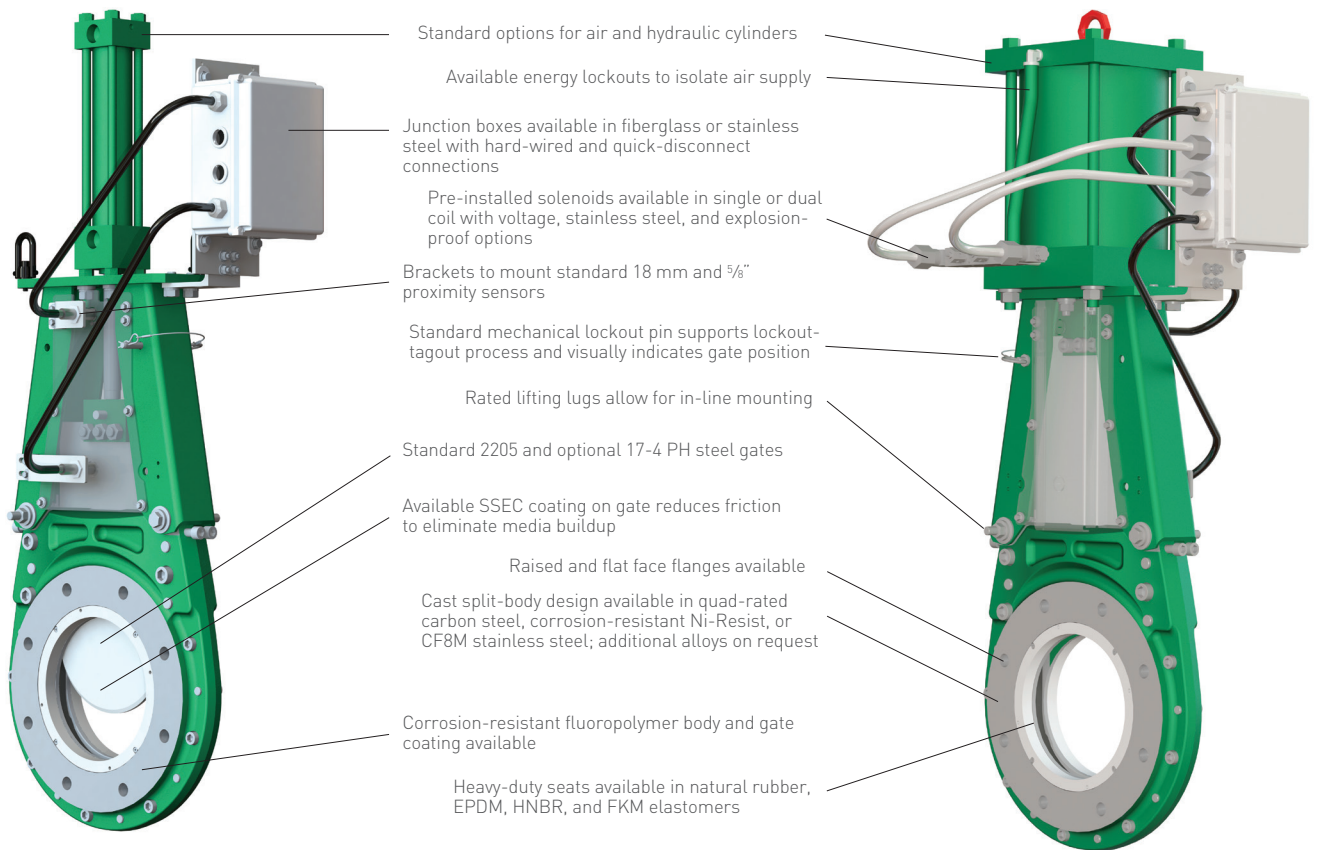

MATERIAL LIST

Component	Material	Properties
Base valve configuration	Body material: WCB/LCB/WCC/LCC	Quad-rated carbon steel for wide temperature range
	Body coating: Clarkson™ Paint	ISO 12944-2 with C3 corrosive rating
	Gate material: 2205 Stainless steel	High corrosion resistance
	Wear ring: A439 D2 Ni-Resist	Improved corrosion resistance and hardness
	Seat material: Natural rubber	175 °F (80 °C) max. temperature High tensile strength, superior tear and abrasion resistance
Optional body materials	A439 D2 Ni-Resist	Improved corrosion resistance and hardness
	Stainless steel CF8M	High corrosion resistance and chemical compatibility materials
	Duplex (4A)	
	Super Duplex (6A)	
Optional body coatings	Fluoropolymer	Typically used with Ni-Resist as a chemical treatment in lieu of paint finish
Optional gate materials	17-4 PH Stainless steel	High abrasion resistance
	2507 Super Duplex	High corrosion resistance and chemical compatibility materials
Optional gate coatings	SSEC	Low coefficient of friction prevents sticky, viscous, corrosive, and/or abrasive media from sticking to the gate, thus reducing drag, improving seat life, and leading to more reliable isolation
Optional seat materials	EPDM	300 °F (150 °C) max. temperature Good resistance to fresh and sea water, steam, alkalis, organic and inorganic acids, silicone oils, bleach solution, ammonia, aqueous abrasive slurries, salt solutions and oxygenated solvents Poor resistance to oil, gasoline and hydrocarbons
	HNBR	300 °F (150 °C) max. temperature Excellent resistance to oil, solvents, sour gas, dilute acids, dilute alkalis, steam and hydraulic fluids. HNBR has good ozone, oxidation and chemical resistance Poor resistance to high polar fluids, aromatic oils, or chlorinated hydrocarbons
	FKM	400 °F (205 °C) max. temperature Excellent resistance to heat, oil, gasoline, hydraulic fluids, and hydrocarbon solvents. FKM possess very good resistance to oxygen, ozone, sunlight Poor resistant to oxygenated solvents, amines, alkalis, formic and acetic acids

CLARKSON SEVERE SERVICE KNIFE GATE VALVES

MODEL KS1

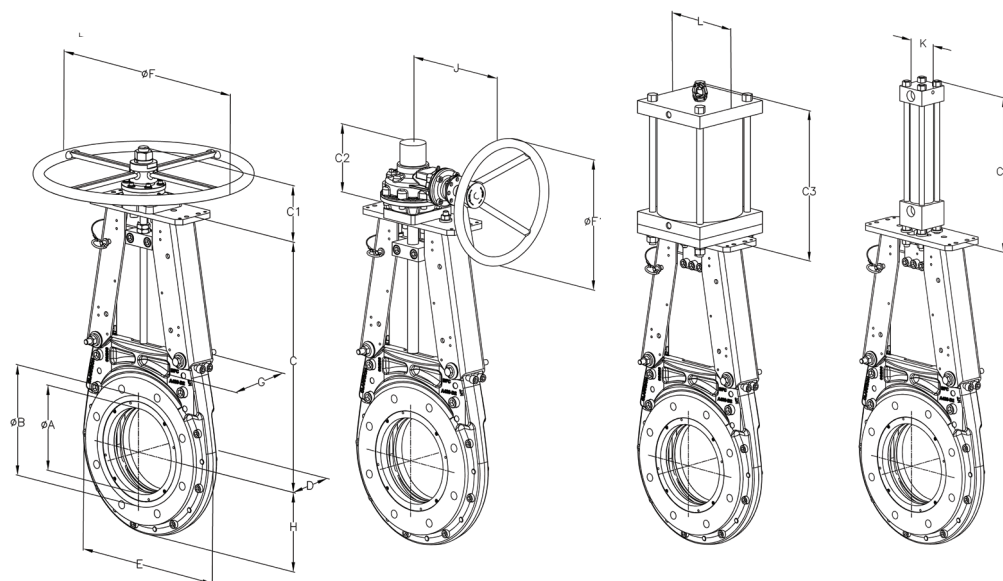

- ØA Valve ID
- ØB Raised face OD
- C Valve center to yoke top plate distance
- D Face to face dimension
- E The maximum valve or upstand clearance dimension for installation
- F Handwheel outer diameter
- G The maximum valve width clearance dimension for installation
- H Valve center to valve bottom distance

DIMENSIONS (inch)

NPS	ØA	ØB	C	C1	C2	C3	C4	D	E	ØF	ØF1	G	H	J	K	L
2	2.0	3.6	9.9	5.5	-	7.3	7.8	2.0	8.5	12.0	-	6.6	4.2	-	2.5	4.5
3	3.0	5.0	12.0	5.5	-	8.3	8.8	2.0	10.0	12.0	-	6.6	5.0	-	2.5	4.5
4	4.0	6.2	14.0	5.5	-	10.1	10.2	2.0	11.2	12.0	-	6.6	5.6	-	2.5	5.5
6	6.0	8.5	18.4	5.5	-	12.8	12.3	2.3	13.4	20.0	-	7.2	6.7	-	2.5	7.5
8	8.0	10.6	22.9	5.5	7.1	15.0	14.9	2.8	16.0	20.0	11.8	8.7	8.0	11.8	3.0	8.5
10	10.0	12.8	27.0	-	7.1	18.7	17.0	2.8	18.2	-	11.8	8.6	9.1	11.8	3.5	10.6
12	13.25	15.0	31.3	-	7.1	20.2	19.0	3.0	21.5	-	11.8	9.8	10.8	11.8	3.5	12.8
14	15.25	16.3	34.4	-	7.4	21.1	21.2	3.0	23.5	-	15.8	9.9	11.8	14.4	4.5	14.8
16	15.25	18.5	38.5	-	7.4	23.9	23.3	3.5	26.3	-	15.8	10.7	13.5	14.4	4.5	17.0
18	17.25	21.0	43.6	-	7.4	26.6	25.8	3.5	28.5	-	15.8	11.9	14.2	14.4	5.0	19.0
20	19.25	23.0	47.8	-	7.5	31.0	28.1	4.5	31.5	-	23.6	12.1	15.7	16.6	5.0	21.0
24	23.25	27.3	57.0	-	8.7	37.4	32.9	4.5	37.1	-	23.6	14.5	18.6	18.1	6.5	25.0
26	25.25	29.5	62.0	-	8.7	39.7	36.4	6.8	38.4	-	23.6	15.8	19.2	18.1	7.5	27.5
28	27.25	31.5	66.9	-	9.9	41.8	38.4	7.1	40.7	-	23.6	17.0	20.3	19.9	7.5	27.5
30	29.25	33.8	70.9	-	9.9	44.7	40.5	7.4	43.2	-	23.6	18.2	21.6	19.9	7.5	29.8

MHW/BG INPUT TORQUE

ft-lb
2
4
5
17
45 (MHW) / 16 (BG)
24
35
39
51
66
93
67
79
72
83

DIMENSIONS (mm)

DN	ØA	ØB	C	C1	C2	C3	C4	D	E	ØF	ØF1	G	H	J	K	L
50	51	92	250	141	-	186	186	51	215	305	-	168	107	-	64	114
80	76	127	304	141	-	210	224	51	254	305	-	168	127	-	64	114
100	102	157	355	141	-	257	259	51	284	305	-	168	142	-	64	140
150	152	216	468	141	-	325	311	57	341	508	-	183	170	-	64	191
200	203	270	582	141	179	380	379	70	406	508	300	220	203	299	76	216
250	254	324	685	-	179	474	431	70	462	-	300	219	231	299	89	270
300	305	381	794	-	179	514	483	76	546	-	300	250	273	299	89	324
350	337	413	872	-	189	537	539	76	597	-	400	251	299	366	114	375
400	387	470	977	-	189	608	591	89	668	-	400	272	343	366	114	432
450	438	533	1108	-	189	676	656	89	723	-	400	302	362	366	127	483
500	489	584	1213	-	191	788	714	114	800	-	600	306	400	422	127	533
600	591	692	1448	-	221	950	836	114	943	-	600	368	472	460	165	635
650	641	749	1576	-	221	1009	924	171	976	-	600	400	488	460	191	699
700	692	800	1699	-	251	1061	976	181	1033	-	600	431	516	505	191	699
750	743	857	1800	-	251	1136	1028	187	1097	-	600	461	548	505	191	756

MHW/BG INPUT TORQUE

N-m
2
5
7
23
61 (MHW) / 21 (BG)
33
47
53
70
89
126
91
107
97
112

NOTES

- Input torque is value at handwheel to open valve at rated pressure.
- Actuator bore size based on required thrust to open valve at rated pressure with 80 psi (5.5 bar) pneumatic or 2,000 psi (138 bar) hydraulic supply pressure. Standard cylinder will close gate at no less than shutoff pressure of 200 psi (13.8 bar).

VCTDS-15713-EN © 2021, 2023 Emerson Electric Co. All rights reserved 01/23. Clarkson is a mark owned by one of the companies in the Emerson Automation Solutions business unit of Emerson Electric Co. The Emerson logo is a trademark and service mark of Emerson Electric Co. All other marks are the property of their prospective owners.

The contents of this publication are presented for informational purposes only, and while every effort has been made to ensure their accuracy, they are not to be construed as warranties or guarantees, express or implied, regarding the products or services described herein or their use or applicability. All sales are governed by our terms and conditions, which are available upon request. We reserve the right to modify or improve the designs or specifications of such products at any time without notice.

Emerson Electric Co. does not assume responsibility for the selection, use or maintenance of any product. Responsibility for proper selection, use and maintenance of any Emerson Electric Co. product remains solely with the purchaser.

[Emerson.com/FinalControl](https://www.emerson.com/FinalControl)