

DCX F

General Description

The DCX Series power supply provides the highest power density in the smallest package on the market today and offers multiple form factors, providing for a high level of flexibility.

DCX F delivers consistent weld quality via continuous monitoring, analysis and closed loop control of the welding process. After the weld cycle ends, the open architecture permits access to all relevant weld data for evaluation. And the advanced communications capability and transparent information flow of the DCX F ensures it can be efficiently integrated into complex, automated processing applications.

The DCX F power supply can also be controlled and parameterized by a FieldBus (ProfiBus, Ethernet IP), making it uniquely adaptable for operating in complex manufacturing lines.

Multiple Weld Modes

DCX F features 5 different weld modes for maximum flexibility in meeting the needs of the widest possible variety of application. The weld mode can be selected based on time, energy, peak power, ground detect, or continuous weld. Weld data can be reviewed instantaneously to verify, evaluate and document the weld, and the user can export weld data into an excel spread sheet.

Additional Capabilities

In addition to its advanced communications capabilities and weld mode flexibility, the DCX F System provides for:

- Slim project engineering efforts and easy setup in an automated environment
- Reduced wiring requirements
- Shorter distance for signal processing



- Less control cabinet space required
- Improved overview
- Less downtime if exchange of power supply is needed
- Easy to accommodate adoptions for actual requirements by extensions or modifications

Ethernet Communication

The Branson Global User Interface Program allows the user to interface with the DCX F power supply via a standard Internet browsing program such as Internet Explorer. The user is also capable of remote communication with the power supply, allowing product configurations and system diagnostics, among other functions.

Higher Productivity

The proven Digital Communication Platform with closed-loop amplitude control provides significant benefits in performance, consistency, and higher productivity, especially in applications requiring a high level of process control, weld quality, and high throughput.

Key Features

Electronic Amplitude Control – Amplitude is an important variable in ultrasonic welding. Electronic amplitude control allows repeatable setups and digital accuracy in selecting amplitude and changing the amplitude during a weld cycle. The DCX F features digital amplitude control through the LCD user interface or through the BUC User Interface Program. The amplitude control also can be set from a user-provided external source through the I/O port. The amplitude rate and level can be changed instantaneously during a weld to increase the weld energy, decrease the weld time, and increase product throughput (Figure 1). The amplitude range is programmable between 10% and 100% output.

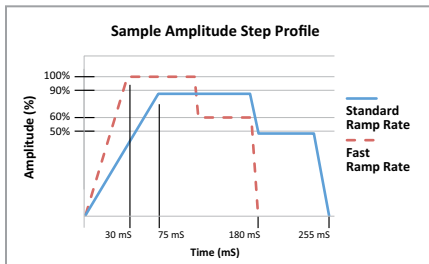

Figure 1

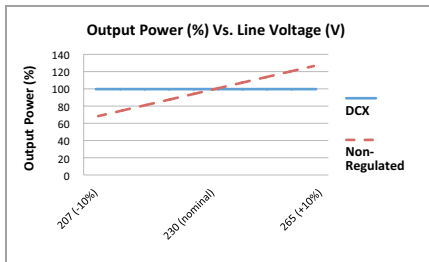

Figure 2

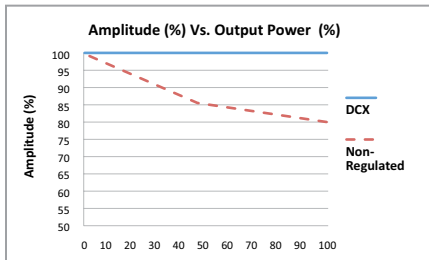

Figure 3

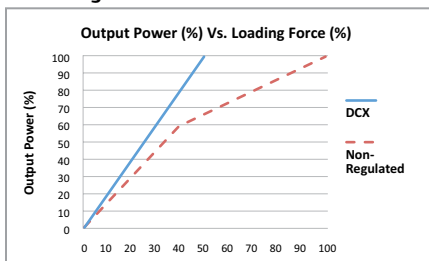

Figure 4

Regulation – The DCX F converter's output amplitude is maintained independent of load force and line voltage variations. Through a closed-loop amplitude control, the amplitude regulation maintains output amplitude by correcting for disturbances in line voltage (Figure 2) and output power loading (Figure 3). A non-regulated power supply's horn amplitude will fall with increasing output power and horn loading force. With constant regulated amplitude, less force is required to deliver output power (Figure 4), and a more stable linear relationship is maintained between amplitude and power. Other advantages of regulated amplitude and lower force include greater weld consistency, less flash, and less deflection of thin-walled parts.

Autotune Plus Memory (AT/M) – AT/M provides fully-automatic tuning in a range of ± 500 Hz centered around 19.950 kHz for 20 kHz horns, ± 750 Hz centered around 30.00 kHz for 30 kHz horns, and ± 1000 Hz centered around 39.90 kHz for 40 kHz horns. The AT/M stores the horn frequency in the DCX controller for consistent and reliable horn starting.

Auto Seek – The Auto Seek function tracks the operating frequency of the stack when the DCX is idle. The Auto Seek function automatically finds the horn's frequency by running the horn at a low-level amplitude (5%) and storing the operating frequency in the DCX controller's memory. Auto Seek is a selectable option and can be initiated by Power-up, by depressing the TEST button, by external command, or by one-minute timed Seek.

Scan – The scan performs a full-frequency analysis of the horn's operating band and stores the primary operating frequency into memory. This ensures reliable horn starting and allows diagnostics and analysis of the horn's resonant frequencies.

Programmable Starting Ramp Times – The ultrasonic starting rate can be programmed from 1 to 999 milliseconds to accommodate the starting characteristics of a wide range of horns. Selecting the shortest possible ramp time can improve the cycle rate.

Front Panel Interface – The icon-driven interface allows the user to read and set the weld amplitude, perform horn tests, configure the DCX weld settings, and clear alarms.

I/O Interface – This interface allows direct hook-up with programmable controllers. I/O status outputs and command inputs are programmable through the BUC User Interface Program and are available through the 26-pin D-shell port.

Power Measurement – Real output RF power to the horn is measured and displayed in 5% increments through the front panel LCD bar graph screen. The output power reading also is available through the I/O port in a relative 0 to 10 V analog output signal.

Enclosure Design – The DCX comes in a vertical or horizontal compact industrial enclosure. The vertical enclosure allows mounting in industrial automation cabinets. The horizontal enclosure allows mounting on bench tops or shelves. Thermal management of the internal components in the DCX is accomplished through a cooling channel, which separates the electronics from the air flow. This new configuration improves cooling performance while minimizing exposure of critical electronic components to debris and contamination.

System Protection Monitor (SPM) – SPM circuitry ensures maximum reliability by necessitating correct operating conditions to protect the power supply, converter, and other system components. The benefit of this circuitry is to avoid equipment failures and downtime.

High Cycle Rate – DCX F is capable of cycle rates in excess of 200 welds per minute. Actual cycle rate is dependent upon the application and controls.

Ordering Information

Note: All sales shall be subject to the Supplier's terms and conditions of sale as described in Branson's quotations and sales contracts.

DCX F Ethernet IP

Description	Branson EDP No.	Description	Branson EDP No.
DCX F (Vertical Mount)		DCX F (Horizontal Mount)	
DCX F-EIP 20:1.25V	101-132-1843	DCX F-EIP 20:1.25H	101-132-1836
DCX F-EIP 20:2.5V	101-132-1844	DCX F-EIP 20:2.5H	101-132-1837
DCX F-EIP 20:4.0V	101-132-1843	DCX F-EIP 20:4.0H	101-132-1838
DCX F-EIP 30:0.75V	101-132-1846	DCX F-EIP 30:0.75H	101-132-1839
DCX F-EIP 30:1.5V	101-132-1847	DCX F-EIP 30:1.5H	101-132-1840
DCX F-EIP 40:0.4V	101-132-1842	DCX F-EIP 40:0.4H	101-132-1835
DCX F-EIP 40:0.8V	101-132-1848	DCX F-EIP 40:0.8H	101-132-1841

DCX F Profibus

Description	Branson EDP No.	Description	Branson EDP No.
DCX F (Vertical Mount)		DCX F (Horizontal Mount)	
DCX F 20:1.25V	101-132-1857	DCX F 20:1.25H	101-132-1850
DCX F 20:2.5V	101-132-1858	DCX F 20:2.5H	101-132-1851
DCX F 20:4.0V	101-132-1859	DCX F 20:4.0H	101-132-1852
DCX F 30:0.75V	101-132-1860	DCX F 30:0.75H	101-132-1853
DCX F 30:1.5V	101-132-1861	DCX F 30:1.5H	101-132-1854
DCX F 40:0.4V	101-132-1856	DCX F 40:0.4H	101-132-1849
DCX F 40:0.8V	101-132-1862	DCX F 40:0.8H	101-132-1855

Cables

Description	Branson EDP No.
RF Converter Cable 8 ft	100-240-383
RF Converter Cable 15 ft	100-240-384
RF Converter Cable 25 ft	100-240-385
RF Converter Cable 50 ft	100-240-386
RF Converter Cable 8 ft Right Angle	100-240-387
RF Converter Cable 15 ft Right Angle	100-240-388
RF Converter Cable 25 ft Right Angle	100-240-389
RF Converter Cable 50 ft Right Angle	100-240-390
I/O Cable 25 ft	100-240-392
I/O Cable 50 ft	100-240-393

Converters

Description	Branson EDP No.
CS-20C	159-135-209
CR-20C	159-135-210
CH-20C	159-135-211
CS-20S	159-135-138R
CR-20S	125-135-115R
CH-20S	159-135-075R
CS-30C	159-135-212
CR-30C	159-135-213
CH-30C	159-135-214
CS-30S	159-135-110R
CR-30S	101-135-081R
CH-30S	101-135-071
CR-40C	159-135-215
CR-40S	101-135-067R

Boosters

O-Ring Mount	20 kHz	30 kHz	40 kHz
Purple (AL), Ratio 1:0.6	101-149-055	-	101-149-087
Green (AL), Ratio 1:1	101-149-051	-	101-149-079
Gold (AL), Ratio 1:1.5	101-149-052	-	101-149-080
Silver (AL), Ratio 1:2	101-149-053	-	101-149-081R
Black (AL), Ratio 1:2.5	-	-	101-149-082
Purple (TI), Ratio 1:0.6	101-149-060	101-149-119	-
Green (TI), Ratio 1:1	101-149-056	101-149-118	101-149-085
Gold (TI), Ratio 1:1.5	101-149-057	101-149-117	101-149-086
Silver (TI), Ratio 1:2	101-149-058	101-149-116	101-149-083
Black (TI), Ratio 1:2.5	101-149-059	101-149-115	101-149-084
Solid Mount	20 kHz	30 kHz	40 kHz
Purple (TI), Ratio 1:0.6	101-149-095	159-149-147	109-041-178
Green (TI), Ratio 1:1	101-149-096	159-149-146	109-041-177
Gold (TI), Ratio 1:1.5	101-149-097	159-149-145	109-041-176
Silver (TI), Ratio 2:1	101-149-098	159-149-144	109-041-175
Black (TI), Ratio 1:2.5	101-149-099	159-149-143	109-041-174

Three Power Supply Sizes

Size	Small			Medium		Large	
DCX F	40:0.4	30:0.75	40:0.8	20:1.25	30:1.5	20:2.5	20:4.0
Frequency	40 kHz	30 kHz	40 kHz	20 kHz	30 kHz	20 kHz	20 kHz
Peak Output Power	400 W	750 W	800 W	1250 W	1500 W	2500 W	4000 W
Max. Continuous Power	200 W	375 W	400 W	625 W	750 W	1250 W	2000 W
Max. Current	3 A	5 A	5 A	7 A	10 A	14 A	25 A
Line Voltage	180-253 VAC, 50/60 Hz, 1 PH			180-253 VAC, 50/60 Hz, 1 PH		180-253 VAC, 50/60 Hz, 1 PH	200-253 VAC, 50/60 Hz, 1 PH
Weight	16 lbs. / 7.25 kg			18 lbs. / 8.16 kg		22 lbs. / 10 kg	

Specifications

DCX Series Dimensions

Dimension	Inch	mm
a	10.63	270.0
b	8.63	219.2
c	7.13	181.1
d	5.53	140.5
e	14.01	355.9
f	0.37	9.4
g	17.38	441.5
h	5.22	132.6
i	4.50	114.3
j	3.50	88.9
k	15.75	400.0
l	3.37	85.6
m	2.37	60.2
n	1.06	26.9

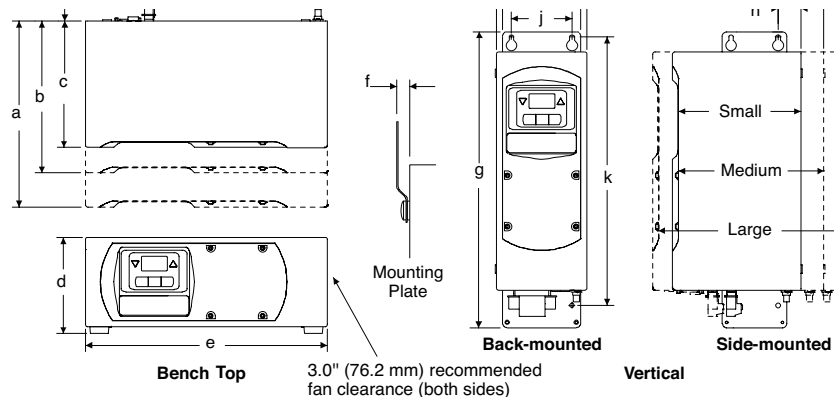

Ordering Key

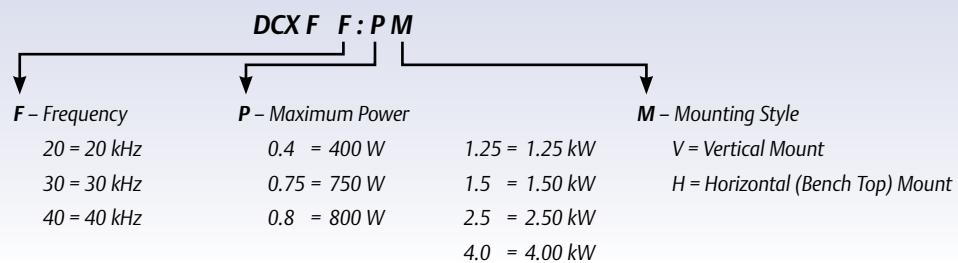

BUC Global User Interface Program

Branson is proud to introduce a new user interface tool that comes standard on all DCX Power Supplies. This eliminates costly software and dedicated computer hardware configuration that often lead to a loss of productivity and time. The connection to this new interface tool is done using a standard RJ45 or Cat 5 cable.

The BUC Global User Interface Program is structured using a standard HTML-based communication interface protocol. This allows the user to employ a commercially available Internet interface program to perform product setup, custom I/O configurations, and system diagnostics, to name just a few functions. The interface also offers a tab structure for simple navigation.

Weld Setup

Allows for setup of the weld mode based on time, energy, peak power, ground detect or continuous weld.

Weld History

Cycle #	Date & Time	Weld Time	Weld Energy	Peak Power	Amp 1	Amp 2	Preset No	Start Freq	Freq Change	Alarm Code	Custom In1	Custom In2
71	05-16-13 10:37:28	00.470	7	3	100	100	0	40175	40175	0		0.0
70	05-16-13 10:37:27	00.662	10	3	100	100	0	40175	40175	0		0.0
69	05-16-13 10:37:21	01.694	82	5	100	100	0	40179	40175	-4		0.0
68	05-16-13 10:37:17	01.896	44	5	100	100	0	40181	40175	-6		0.0
67	05-16-13 10:37:10	00.070	0	2	100	100	0	40175	40900	1000	B13	0.0
67	05-16-13 10:14:40	00.070	0	2	100	100	0	39900	40900	1000	003	0.0
66	05-13-13 09:37:59	01.594	36	2	100	100	0	40189	40190	1		0.0
65	05-13-13 09:34:57	01.261	28	2	100	100	0	40190	40189	-1		0.0
64	05-13-13 09:34:52	03.813	86	2	100	100	0	40191	40190	-1		0.0
63	05-13-13 09:34:40	04.342	80	2	100	100	0	40192	40191	-1		0.0
62	05-13-13 09:34:27	01.742	33	2	100	100	0	40193	40192	0		0.0
61	05-13-13 09:34:22	02.021	36	2	100	100	0	40193	40192	-1		0.0

Enables the user to verify, evaluate, and document the weld results, as well as export data to an Excel spreadsheet.

Weld Graph

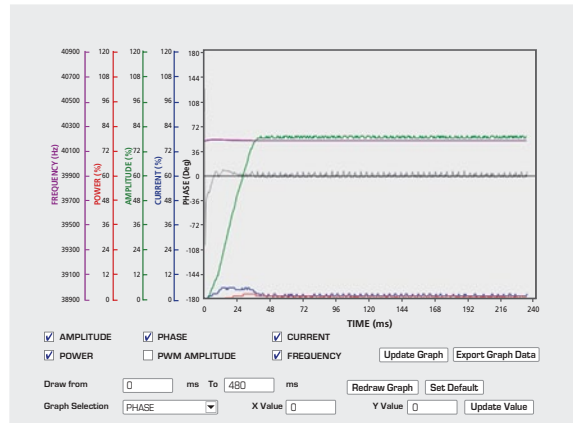

Provides for the graphing of the weld data, as well as testing the stack and displaying output power, frequency and amplitude.

Horn Signature Diagnostics

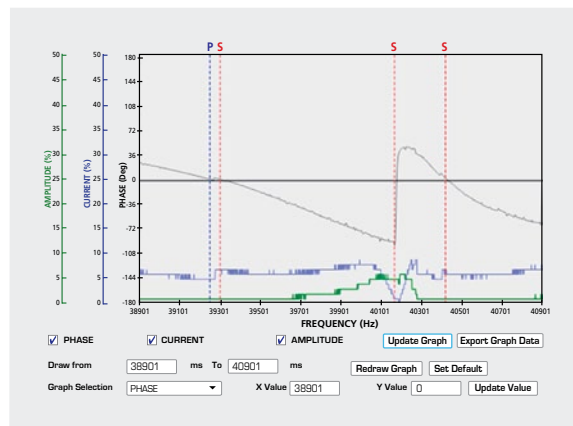

Allows for documenting the stack performance via a complete horn scan that graphically reports the parallel and resonant frequencies present.

FieldBus Info

Allows analysis of FieldBus communication between P/S and the PLC, and test PLC commands from and to the DCX F/P/S.

True Global Support & Service

Branson Ultrasonics is the world leader in materials joining with more than 1,800 employees and 70 sales and support offices. We are committed to leading the industry in products, solutions, service and support excellence. That means fast delivery, troubleshooting, parts replacement, feasibility studies, cooperative research, preventative maintenance and repair services. Branson is part of the Industrial Automation division of Emerson, a diversified international manufacturing and technology company committed to developing technological breakthroughs that advance the performance of a wide range of products and processes.



WARRANTY

The Branson DCX ultrasonic welding power supplies carry a three-year warranty on materials or workmanship.

Note: This warranty applies to equipment purchased and operated in North America. For warranty information on units purchased and/or operated outside the U.S. contact your local representative.

All specifications subject to change without notice. All dimensions are nominal. All units are CE compliant and comply with FCC rules and regulations governing radio frequency interference.



Americas

Branson Ultrasonics Corp.
41 Eagle Road
Danbury, CT 06810, USA
T: 203-796-0400
F: 203-796-0450
www.bransonultrasonics.com

Europe

Branson Ultraschall
Niederlassung der Emerson
Technologies GmbH & Co. OHG
Waldstrasse 53-55
63128 Dietzenbach, Germany
T: +49-6074-497-0
F: +49-6074-497-199
www.branson.eu

ASIA/PACIFIC

Branson Ultrasonics (Shanghai)
Co., Ltd. (China H.Q.)
758 Rong Le Dong Road
Song Jiang
Shanghai, PRC, 201613
T: 86-21-3781-0588
F: 86-21-5774-5100
www.branson.com.cn