

Increase productivity throughout
the lifecycle of your facility.

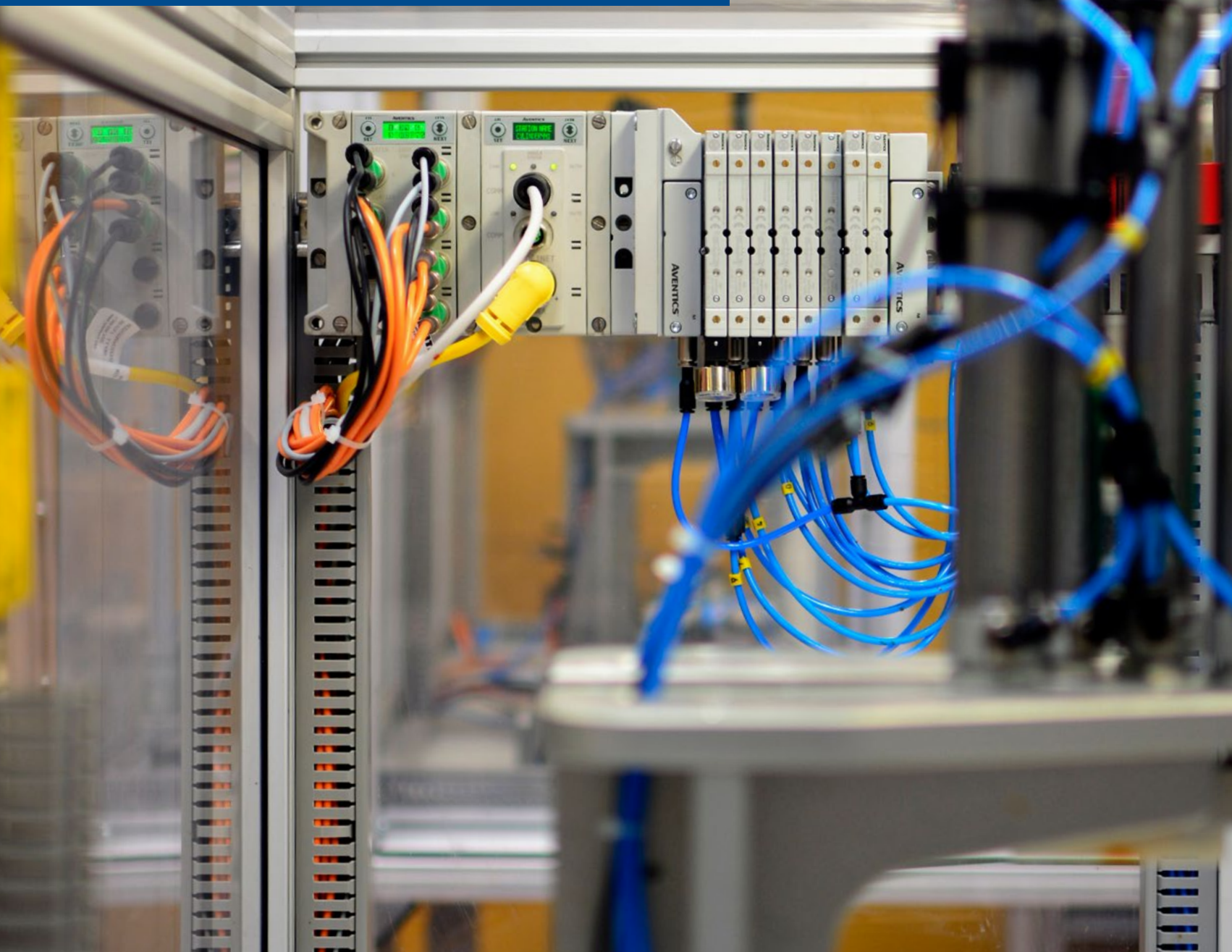

AVENTICS™ Series 500 Valve Systems and G3 and 580 Electronics

Flexible, modular fluid automation solutions that simplify the design
and operation of your pneumatic systems



Your machinery and processes must help to increase operating equipment effectiveness and reduce operational costs.

Global competition is reducing the profit margins for manufacturers. Meeting safety compliance requirements, which further affect productivity and profitability, only compounds the issue. When you design or invest in new machinery or processes, it must not only support greater operating equipment effectiveness over the course of its lifecycle, but also provide the lowest possible total cost of ownership, contributing towards reduced operational costs. Increasingly competitive industries also require that final products are brought to market as quickly as possible. To achieve this, you must bring new machinery or processes online faster and they must provide the flexibility to cope with different manufacturing processes driven by changing consumer demand.

“Manufacturing companies can only be competitive if their production facilities are available and productive.”

– Fleischer et al., 2006



“The ownership costs throughout a system’s entire lifecycle can become 20 to 200 times more than the initial purchase price.”

– J Seif, M Rabbani, Journal of Quality in Maintenance Engineering 2014



“A product delay can cost a company 15 to 35 percent of the Net Present Value (difference between the present value of future cash flows from an investment and the amount of investment).”

– OakStone Partners, 2013



“To succeed in an environment with shifting demands, a business needs to be adaptive and receptive to change.”

– PWC report, Agile Project Delivery Confidence, 2017





Ensuring safety compliance can increase project timelines and reduce machinery productivity. What if fluid automation technology could simplify machinery integration and increase uptime while making your process safer?

AVENTICS Valve Systems help to reduce the critical path of your project and reduce total cost of ownership.



When automating a simple machine or even a complex process, AVENTICS Valve Systems help to ensure on-time project delivery, enhanced safety, increased productivity over its lifecycle, and lower total cost of ownership. By simplifying installation, commissioning, and integration with other systems, the valve systems enable you to reduce critical paths of fluid automation projects and get production started sooner. Robust, high-performance valve options are supported by advanced diagnostics for predictive maintenance that contribute towards maximum overall equipment effectiveness.

AVENTICS™

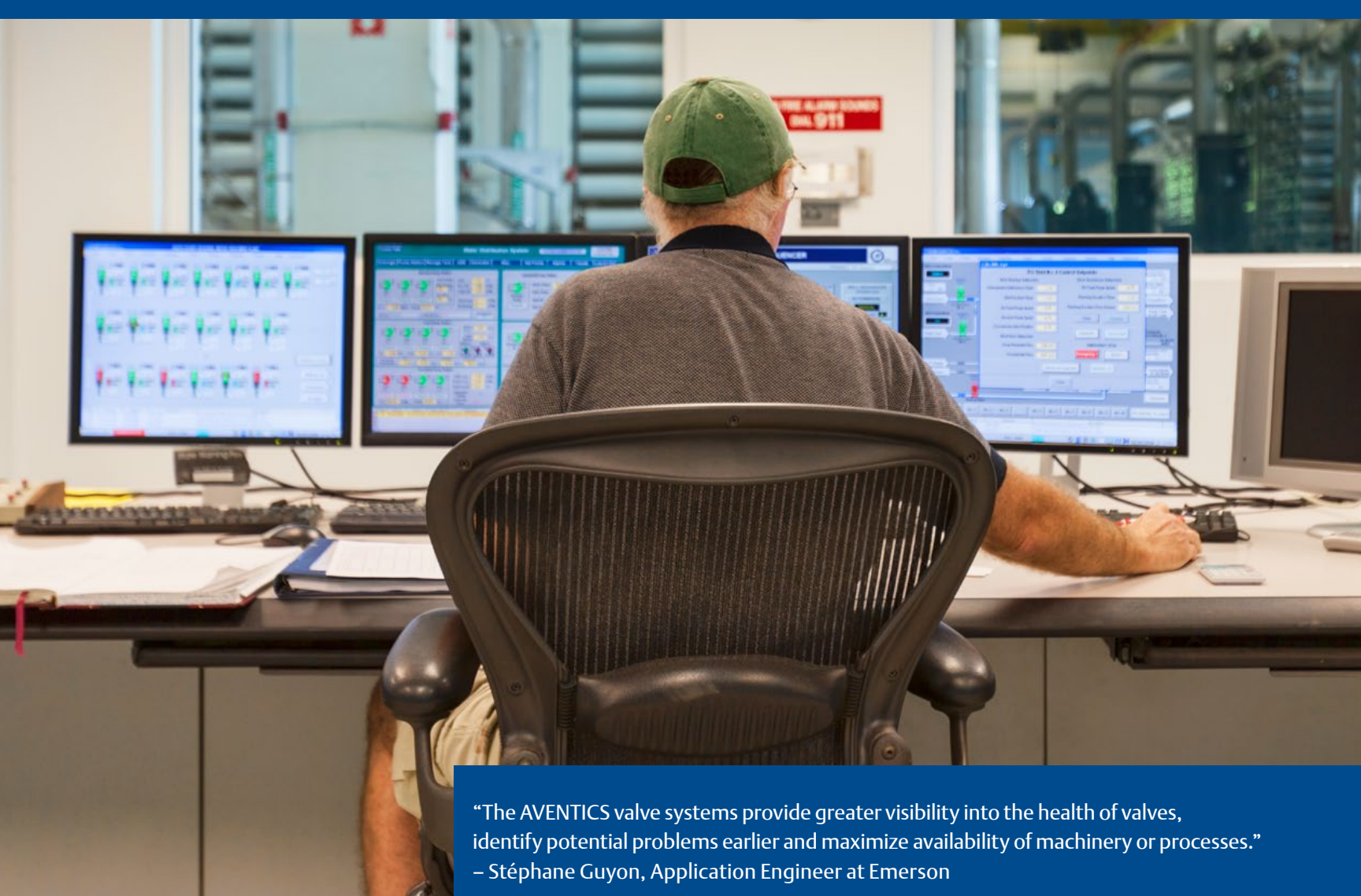

“The AVENTICS valve systems provide greater visibility into the health of valves, identify potential problems earlier and maximize availability of machinery or processes.”
– Stéphane Guyon, Application Engineer at Emerson

Don't let increased safety requirements reduce productivity.

An automotive plant in the US wanted to maintain the safety of machinery and employees without adding complexity or affecting production. Using AVENTICS valve systems they were able to isolate power to the group of valves in the operator's vicinity. Since the whole system does not need to be re-pressurized on start-up, this helps improve productivity.

Overall Equipment Effectiveness ► p6

Start production faster by reducing the critical project path.

A water treatment plant in Belgium required better control of its pneumatic valves. Emerson engineered, built, and fully certified five control enclosures incorporating valve systems with Profibus connectivity. This opened up customer resources allowing them to concentrate on other areas of the project.

Delivery Times ► p10

Reduce the total cost of ownership, from design through operation.

“We chose Emerson for their expert design and customization, along with their ability to go above and beyond our needs. Using modular valves was a particular benefit, as we can now easily carry out maintenance on the machine, expanding its lifespan and maximizing our customer's investment.”

– Philip Vorrsselmans, senior project and automation manager, Crown-Beale

Total Cost of Ownership ► p8

Deliver on time despite late project changes.

At a Danish pharmaceutical manufacturing facility, a turnkey enclosure solution, including an AVENTICS valve systems and CHARMs electronic marshalling, helped to reduce fluid automation complexity and commissioning time. This ensured the overall automation project remained on schedule.

Flexibility ► p12

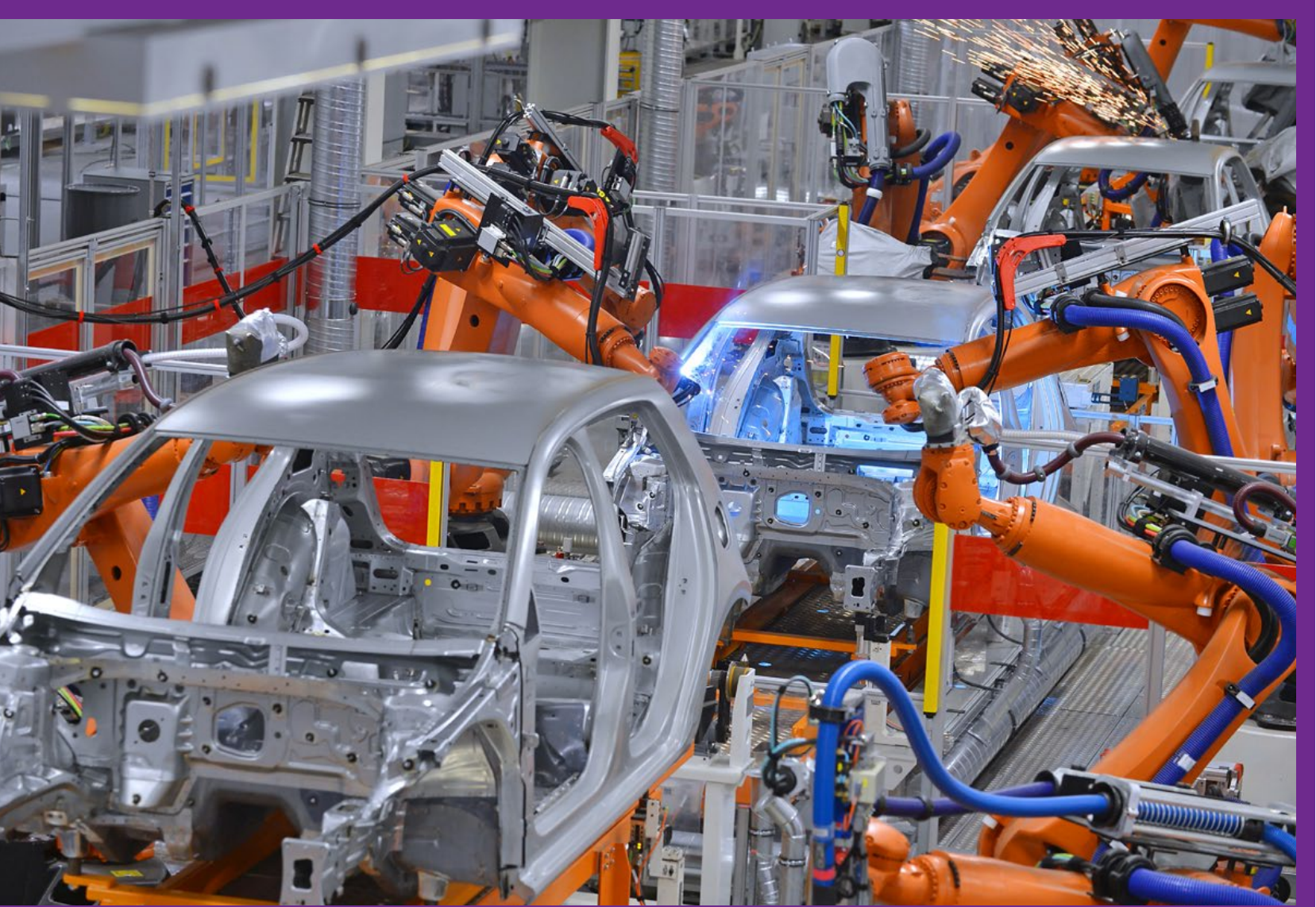

Maximize **OVERALL EQUIPMENT EFFECTIVENESS** throughout the process lifecycle.

Increasingly competitive markets are putting pressure on your profit margins, making it essential that machinery and processes are as effective as possible. However, increasing safety legislation can potentially reduce productivity. AVENTICS valve systems help you achieve greater overall equipment effectiveness by offering robust, machinery safety-compliant solutions that maximize process availability. Simplified commissioning, installation, and integration produces faster start-ups, while enhanced diagnostic capability helps to identify problems earlier – contributing towards increased equipment uptime and greater productivity.

What's your challenge?



"Manufacturing companies can only be competitive if their production facilities are available and productive."
– Fleischer et al., 2006

What's your opportunity?



Aging pneumatic control system wiring made diagnosing issues difficult for a large utility company at one of its power plants. By transitioning to a modular I/O solution provided by the AVENTICS valve systems, this reduced wiring complexity, simplified troubleshooting, cut labor and material costs, and reduced system downtime that was disrupting workflow.

Reduce maintenance and downtime



Auto recovery module (ARM) protects configuration data during critical failure while the Wireless ARM allows access to vital valve system diagnostics and health monitoring via WiFi connection.

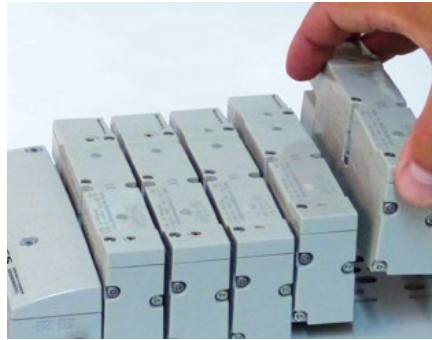

Plug-and-play valves can be replaced quickly and easily, helping to prevent long interruptions to production. ▶ p14



Metallic manual override on valves is very robust and less prone to damage that may result in machinery or process being taken offline for repair.

Maximize availability and throughput

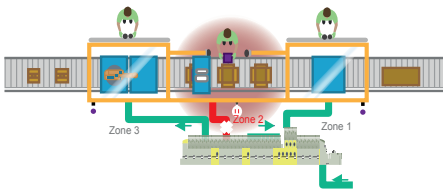

Zoned Safety capability enables isolation of up to three safety zones on a machine from one single valve system, improving productivity, and reducing cost and complexity. ▶ p16



Modular system is very easy to modify should a machine or process be changed within the lifecycle of the plant, resulting in faster turnaround. ▶ p14



CHARMs node and Electronic Marshalling provide simple connection and integration to the control system enabling faster start-ups. ▶ p13

Gain greater insight into valve health



Unique graphical display offering plain language diagnostic information makes faults easier to diagnose and simplifies configuration. This enables you to get production started again much quicker.



Ethernet and fieldbus connectivity provides access to valve health information enabling maintenance to identify faults earlier and improve maintenance scheduling. ▶ p14



Need help to choose, implement and optimize the right solution for your application, visit [Emerson.com/en-us/automation/fluid-control-pneumatics/pneumatic-valves-valve-systems](https://www.emerson.com/en-us/automation/fluid-control-pneumatics/pneumatic-valves-valve-systems)





Reduce your TOTAL COST OF OWNERSHIP.

With many markets becoming increasingly price sensitive, manufacturers need to minimize operating costs and reduce the total cost of ownership of their machinery and processes from design through operation. AVENTICS valve systems help by simplifying the design process and reducing engineering and installation costs. The modular design of the valve systems and high-performance valves help to reduce overall footprint and equipment costs. By offering greater reliability and a range of diagnostic functions, you can minimize maintenance requirements to ensure lifecycle costs are lower.

What's your challenge?



"The ownership costs throughout a system's entire lifecycle can become 20 to 200 times more than the initial purchase price."

– J Seif, M Rabbani, Component-based lifecycle costing in replacement decisions. Journal of Quality in Maintenance Engineering 2014

What's your opportunity?



The packaging division of a large global company achieved annual energy savings of almost \$8,000. The solution: High-performance AVENTICS Series 503 valves that prevented compressed air leakage and reduced energy and maintenance costs.

Reduce equipment costs



Compact modular valves offer the highest flow rate for their size. Using more compact valves helps to reduce machine footprint and lower costs. ▶ p15



Single node can pilot up to 128 coils, creating a very cost-effective solution. ▶ p14

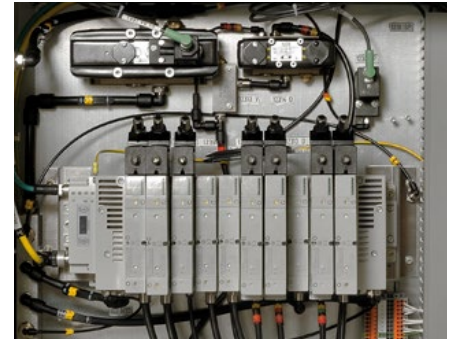

Integration of multiple process product types reduces the footprint of the installation.

Minimize engineering and installation costs



Easy integration with PLC or distributed control systems, making it a plug-and-play solution that reduces commissioning and installation time and cost.



Connectivity to a broad range of communication protocols that simplify and reduce wiring, contributing towards lower installation costs. ▶ p14

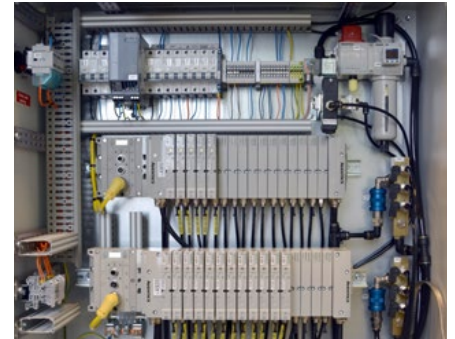

Preassembled, ready-to-install custom solutions that lower the risk of costly design amendments during the production phase. ▶ p19

Lower operating costs



Robust and reliable technology supported by diagnostics available locally and through a communications network that assists with minimizing maintenance costs.



High-performance valves offering greater flow from a smaller device, reducing energy costs. ▶ p15



Need help to choose, implement and optimize the right solution for your application, visit Emerson.com/en-us/automation/fluid-control-pneumatics/pneumatic-valves-valve-systems





Reduce your critical project path to MEET TIGHTER DELIVERY TIMES.

Manufacturers and OEMs alike are under increasing pressure to design, install, and start up new manufacturing lines faster in order to bring products to market earlier. A manufacturing delay can have a significant impact on overall profitability of production. Emerson and its AVENTICS valve systems help to provide the required assurance that machines and processes will be delivered on time, and can help reduce the critical path of a project to enable production to begin sooner.

What's your challenge?



“A product delay can cost a company 15 to 35 percent of the Net Present Value (difference between the present value of the future cash flows from an investment and the amount of investment).”

– OakStone Partners, 2013

What's your opportunity?

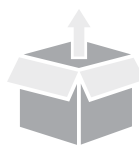

An active pharmaceutical ingredient manufacturer required a valve actuation solution that would help maintain plant up-time and was simple to install, ensuring faster start-up. A complete pre-wired enclosure solution, including AVENTICS valve systems, reduced commissioning time and installation costs, with individual shut-off modules helping to reduce downtime.

Greater assurance of on-time project delivery



Wide range of I/O options using a single device simplifies purchasing and engineering. ▶ p14

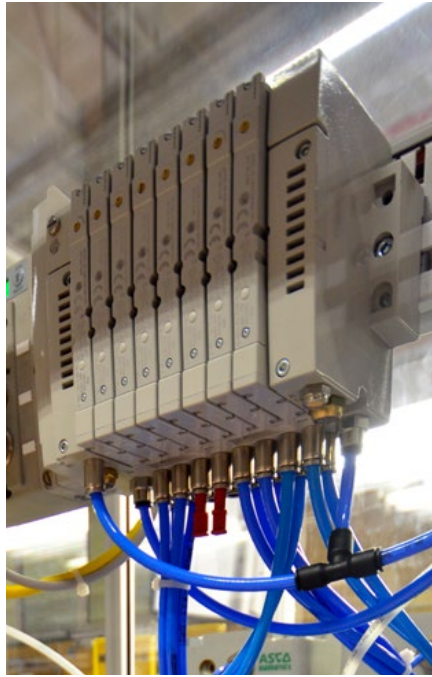

The option of pre-assembled and ready-to-install systems can ensure that your project finishes on time and on budget. ▶ p19

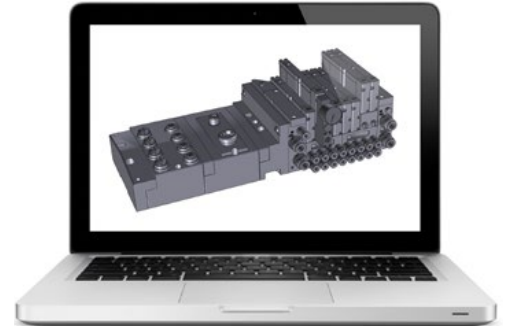

Online configurator tool enables a full system to be defined, reducing manual assembly or configuration on site and getting production started quicker. ▶ p18

Easier commissioning for faster start-up



Wide range of valves and modular options enables every possible configuration to be met by a single supplier, reducing potential commissioning headaches. ▶ p15



Graphical display provides clear feedback when commissioning valves, reducing the time required and shortening the critical path of the project. ▶ p14



I/O on demand via the CHARMs node reduces system complexity, keeping your project on track. ▶ p13



Need help to choose, implement and optimize the right solution for your application, visit [Emerson.com/en-us/automation/fluid-control-pneumatics/pneumatic-valves-valve-systems](https://www.emerson.com/en-us/automation/fluid-control-pneumatics/pneumatic-valves-valve-systems)





Flexibility to make LATE CHANGES to a machine.

As a project evolves, changes are often made to a machine or process design. Should these occur late within the project cycle, they can adversely affect the overall delivery date. Once installed, there is often a need to modify or extend machinery to meet changing production demands. AVENTICS valve systems help you to meet these challenges by offering the flexibility to cope with any last-minute design changes and ensure projects are delivered on time. The valve systems also reduce the challenge of making modifications to a manufacturing process at a later stage, without the need to invest heavily in additional engineering and components.

What's your challenge?



“To succeed in an environment with shifting demands, a business needs to be adaptive and receptive to change.”
– PWC report, Agile Project Delivery Confidence, 2017

What's your opportunity?



When fully automating air testing machines used for quality control, a major brake line manufacturer required a solution that was easy to install and maintain, and flexible for future expansion. AVENTICS G3 valve systems were applied to 12 machines, providing them with plug-and-play capability, simple commissioning and maintenance, and easy I/O expansion.

Take last-minute changes in your stride

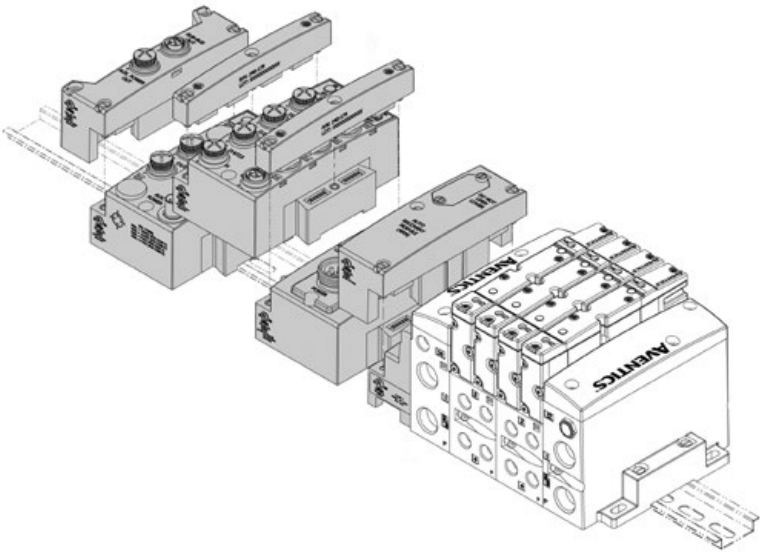

Modular system uses an innovative clip design to allow easy replacement of modules, without having to dismantle the whole manifold, enabling effortless last-minute changes. ▶ p14



CHARMs node and Electronic Marshalling enable late I/O changes, helping to overcome late changes in project design.

- Reduces installation complexity by eliminating all the design, engineering, and disruptive work associated with traditional cross-marshalling.
- Enables simple and quick integration of pneumatic systems with the DeltaV™ Distributed Control System.

Flexibility to make modifications

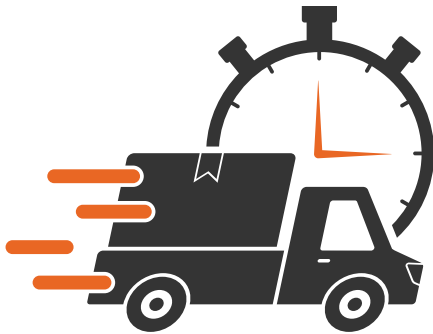

Emerson guarantees **short-term deliveries** on an extensive range of valves to overcome late changes and on-site modifications.



Flexible modular design enables production line adjustment, extension or even reduction with minimal engineering. ▶ p15



Need help to choose, implement and optimize the right solution for your application, visit [Emerson.com/en-us/automation/fluid-control-pneumatics/pneumatic-valves-valve-systems](https://www.emerson.com/en-us/automation/fluid-control-pneumatics/pneumatic-valves-valve-systems)



AVENTICS valve systems: Efficient fluid automation throughout your process lifecycle.

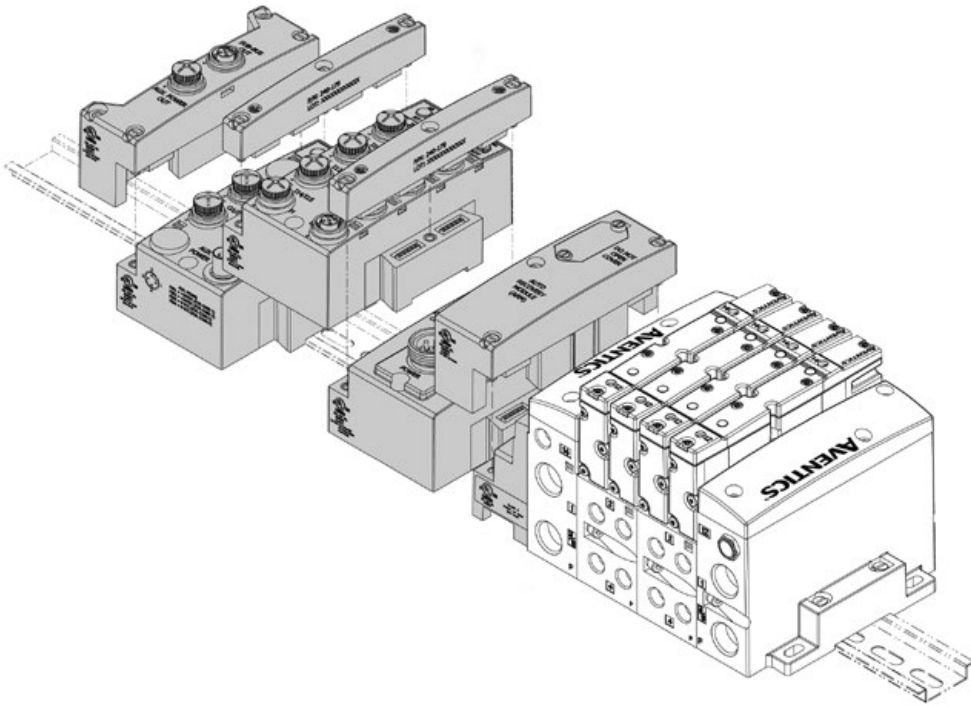

Digital connectivity

- G3, 580 and Multipol electronics platforms provide digital connectivity
- DeviceNet™, DeviceLogix, EtherCAT®, Ethernet/IP™, Ethernet POWERLINK, CANopen, CC-Link IE, MODBUS TCP, PROFIBUS-DP®, PROFINET® and IO-Link communications
- I/O on demand using Electronic Marshalling enables connection to DeltaV distributed control system
- I/O capabilities including analogue, digital (on/off) and temperature

Flexible modular platform

- Innovative clip design allowing easy module removal and replacement
- Mix of flow rates and pressures allowing valve piloting and pneumatic systems from same manifold
- Broad range of sandwich components

Robust valve options

- Breadth of valve options enables single supplier to meet all requirements
- Compact valves that reduce the overall system footprint
- Extreme temperature solutions
- Hazardous area approvals

AVENTICS pneumatic valve systems overview

By supporting fluid automation applications that control production worth billions of dollars, the AVENTICS valve systems have become the industry's leading pneumatic valve system solution. They offer a complete plug-and-play modular system that provides great flexibility in terms of design and installation. Innovative features, such as digital displays, simplify commissioning and fault diagnosis. A huge range of compact, modular, class-leading valves provide high performance and reliability, while connectivity to digital communication protocols

and I/O on demand solutions enable seamless integration into your existing plant control system. Machinery safety compliant and suitable for high or low demand applications, including hazardous and extreme environments, the valve systems are designed to maximize the availability of your process or machinery, minimize total cost of ownership, and help maximize production profitability.

[Emerson.com/en-us/automation/fluid-control-pneumatics/pneumatic-valves-valve-systems](https://www.emerson.com/en-us/automation/fluid-control-pneumatics/pneumatic-valves-valve-systems)

Digital connectivity enables simple integration

G3 electronics



- G3 electronics platform provides fieldbus and Ethernet connectivity and graphical user interface

580 electronics

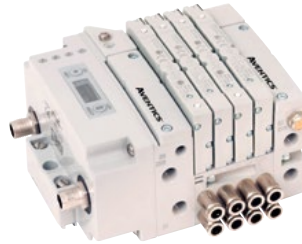

- 580 electronics platform provides a compact cost-efficient solution

Multipol



- Multipol pneumatic spool valve system with connectivity via multiwire cable (Multipol)

Flexible modular platform expands capabilities

Transition plate



- Transition plate enables different sized valves with different flow rates to be installed on the same manifold

Subbase



- Subbase allows two different air pressures on the same valve system, without individual regulators

Modular options



- Pressure regulators, pressure shut-off, exhaust flow control, 24V DC, and air pilot zoning for machine safety integration
- Optional lockable shut-off valve to improve safety of operator during maintenance

Robust valve options support all your applications



Series	501	502	503
Connection	M7 2,7x4 or 4x6mm	G1/8 or NPT 4x6 or 6x8mm	G1/4-G3/8 or NPT 6x8 or 8x10mm
Width	11mm	18mm	26mm
Flow (l/min) ANR	400	650	1400
Cv	0.40	0.65	1.40
Pneumatic function	5/2 single or double solenoid, 5/3 W1, W2 W3, 2 x 3/2 NC- NC, 2 x 3/2 NO-NO		
Technology	Rubber pack	Spool and sleeve or rubber pack	Spool and sleeve or rubber pack
Temperature	-10°C to +50°C / 14°F to 122°F		

W1: 5/3 closed centre position W2: 5/3 centre open to pressure W3: 5/3 centre open to exhaust NO: Normally open NC: Normally closed

AVENTICS Zoned Safety approach: Eliminate cost and complexity in machine safety applications.

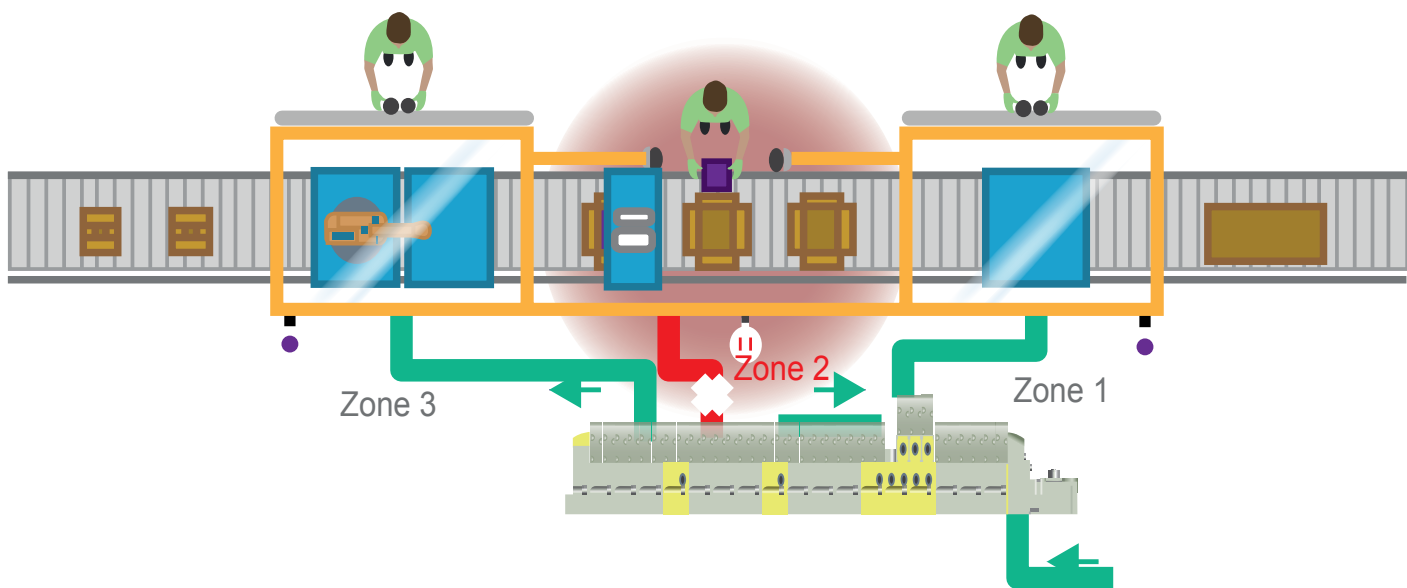

Overview

Zoned Safety technology, available with AVENTICS valve systems, simplifies the design of redundant pneumatic safety circuits. It enables up to three independent electro-pneumatic safety zones to be set up, while also allowing independent non-safe sections to co-exist within a single valve system assembly. Alternative solutions only enable the isolation of one zone per valve system, which increases cost and complexity.

Zoned Safety greatly simplifies safety circuit design and reduces the number of system components. It is recommended for any pneumatically controlled production equipment requiring compliance with Machinery Directive 2006/42/EC and the EN ISO 13849-1 standard.

Benefits of a Zoned Safety approach

- Ability to greatly simplify the design of a redundant pneumatic safety circuit with a valve system
- Less expensive approach to safety than circuits designed using dump valves and other components to achieve diverse redundancy
- Meets the requirements of Machinery Directive 2006/42/EC and the EN ISO 13849-1 standard

Eliminates components



- Reduce the number of safety system components by up to 35%, optimizes the use of safety networks, and requires less plumbing

- No redesign or safety redundant dump valve is required for zone control

Smaller footprint



- Significantly reduces safety system size, freeing up valuable space within the machine and valve system
- Compatible with various fieldbus protocols and user has optimal choices when selecting valve options, accessories, and flow requirements
- Suitable for most manual load/unload stations and a wide variety of industrial applications

Improve productivity and asset availability



- Air and power are disabled only to the components controlling equipment in the operator's vicinity. Remainder of machine can continue operating when these safety circuits are enabled
- Does not require frequent shutdown of the entire production machine

Online configurator and tools.



Overview

To improve operational and maintenance efficiency, Emerson offers a web server service that enables users of the AVENTICS G3 fieldbus electronics to set parameters, view documentation, check diagnostics, and review a history of events via any browser. Providing secure remote access over the internet reduces the need for costly maintenance trips and allows system integrators and machine builders to provide off-site support. [Emerson.com/en-us/catalog/aventics-g3](https://emerson.com/en-us/catalog/aventics-g3)

To save time when designing pneumatic valve system installations, Emerson has created a flexible and powerful online product configurator tool. The configurator is very intuitive and has logical menus to simplify product and option selection. This helps to guide the user through the process of designing a system that meets the needs of their specific application. Selections include the desired fieldbus protocol, the number of I/O stations, type of I/O, quantity and type of valves, function, and any options required. [Emerson.com/AVENTICS](https://emerson.com/AVENTICS)

Benefits of product configurator and CAD library

- Provides designers with assurance that the final manifold will fit onto their machine
- Enables engineers to configure and select a manifold for a specific project on their plant
- The resulting CAD files and part number information are designed to meet every aspect of your design requirements in a single file

Complete turnkey AVENTICS valve system solutions.

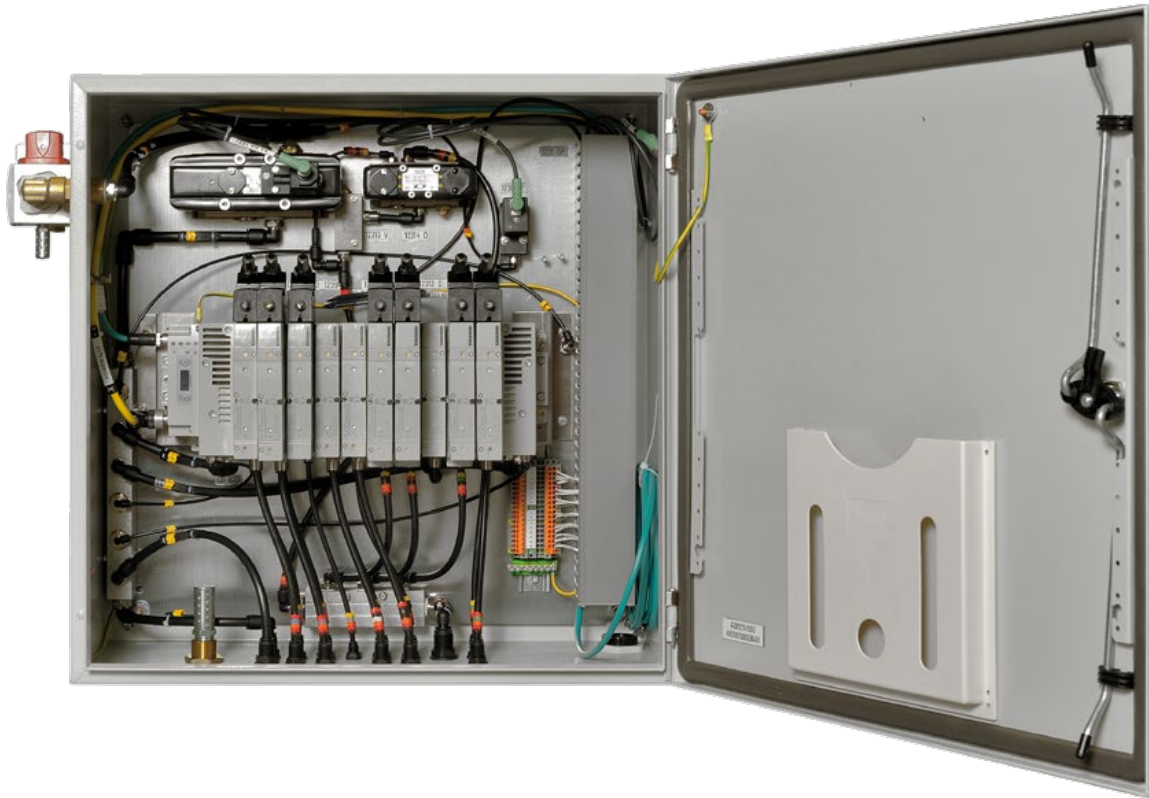

Overview

For customers who may be tight on time or short on resources, Emerson offers fully pre-assembled, ready-to-install systems, specifically built, tested and certified to your specifications. Whether you require pre-assembled products, panel mounted solutions or multifunctional enclosures, solutions can be provided for different levels of integration. Our team of experienced design engineers uses engineering software to create three-dimensional models from P+ID drawings. This enables us to deliver custom solutions for your application – lowering the risk of design amends during the production phase. Furthermore, by providing testing, assembly, delivery, and installation, Emerson’s solutions offer numerous opportunities for integration and savings.

Benefits of pre-assembled, ready-to-install systems

- Reduction in assembly costs, R&D and procurement can translate into savings of up to 30%
- Simplified designs can reduce overall footprint, time, and cost savings during installation
- Pre-assembled solutions in enclosures ensure corrosion- and damage-resistant installations. ATEX, NEMA and UL certified and hygienic solutions available
- Optimized, tested and certified ready-to-install turnkey systems provide seamless integration with other systems, reducing project risk

Increase productivity and reduce total costs throughout the lifecycle of your machinery or processes.



AVENTICS™

With its flexible modular design, breadth of class-leading valves, digital connectivity and diagnostic capabilities, AVENTICS valve systems are designed to maximize the potential of your fluid automation application.

Visit us: [Emerson.com/AVENTICS](https://emerson.com/AVENTICS)

Your local contact: [Emerson.com/contactus](https://emerson.com/contactus)



[Emerson.com](https://emerson.com)



[Facebook.com/EmersonAutomationSolutions](https://facebook.com/EmersonAutomationSolutions)



[LinkedIn.com/company/Emerson-Automation-Solutions](https://linkedin.com/company/Emerson-Automation-Solutions)



[Twitter.com/EMR_Automation](https://twitter.com/EMR_Automation)

The Emerson logo is a trademark and service mark of Emerson Electric Co. Brand logotype are registered trademarks of one of the Emerson family of companies. All other marks are the property of their respective owners. © 2020 Emerson Electric Co. All rights reserved.
BR000140ENUS-01_07-20



EMERSON™

CONSIDER IT SOLVED™