

**Solve your unique and complex
fluid handling challenges.**



Rapid Engineered Solutions

Faster access to valve samples and customized assemblies to support development of your unique analytical instrumentation and medical devices.



You need suppliers that help reduce product development time, enabling you to bring your device to market faster.

Bringing analytical and medical products to market faster is essential for your company to maximize profitability. As a design engineer for an original equipment manufacturer, you face highly compressed timelines to accomplish new product development. That requires experts to help reduce the complexity of your fluidic system challenges and suppliers that are responsive and can help contribute to faster launches, not delays. Your purchasing department also wants to streamline the supply chain. You need to partner with a valve supplier that offers a comprehensive portfolio, including industry-proven plug-and-play assemblies and modules that simplify installation and deliver assured reliability, fewer field failures and increased uptime.

“More collaboration between device developers and their supply chain partners to explore how alternative designs and materials might alleviate some design complexity, enabling products to be manufactured faster and potentially more cost-effectively, with fewer overall inputs”

– MDDI - Medical Device and Diagnostic Industry, 2019



“Medical device companies are often met with challenges in their drive to cost-effectively design devices that respond to market dynamics or solve unmet medical needs for patients. It’s critical to have a partner that can successfully counsel and support OEMs when a device requires a redesign or design alteration.”

– Medical Design and Outsourcing, 2020





Instead of being bogged down by your fluid control challenge, what if your supplier could optimize your fluidic path design and provide fully functioning prototypes at rapid speed that allow you to keep your project on track?

Emerson's Rapid Engineered Solutions help you bring your medical device to market faster.

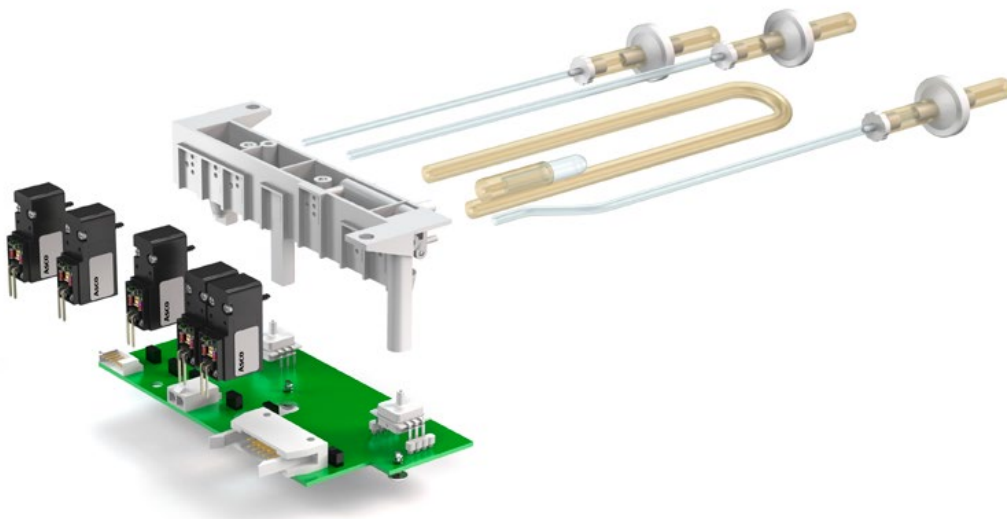

Rapid Engineered Solutions from Emerson help analytical and medical equipment manufacturers accelerate the fluid handling design and engineering phase of new product development. Our global team of experts work directly with your engineers to simplify and optimize the fluidic path design, maximize efficiencies and reduce costs. A comprehensive portfolio of industry-proven 'standard catalog' valves support fast qualification and testing, and enhance device quality and reliability. We excel in designing and manufacturing customized solutions and fully functional prototypes tailored to the exact specifications of your device at unprecedented speeds. Ultimately, partnering with Emerson helps bring your new products to market faster.

ASCO[™]



“Emerson’s global engineering team worked closely with our design engineers to develop a highly customized assembly for our analytical instrument, all within an extremely accelerated timeline.”
– Design engineer, manufacturer

Don't let valves extend your lead times.

A leading material characterization instrument manufacturer worked with Emerson experts to develop a customized miniature solenoid valve for its industrial analyzer. The solution lowered the valve-related rejection rate from 40% to zero and eliminated the time-consuming valve cleaning and inspection processes, significantly improving lead times.

Faster ► p6

Increase the performance and lifecycle of your device.

A leading manufacturer of surgical equipment for laparoscopic procedures had problems with existing valves controlling suction for lens cleaning. Fulfilling the customer's rapid delivery schedule, Emerson provided the ASCO™ Series 284 pinch valve, which offered the required reliability, repeatable response and leak-free sterile design.

Costs ► p8



Bring new product designs to market FASTER

Throughout the analytical and medical industries, the development time for instrumentation is decreasing, while the complexity increases exponentially. Emerson's Rapid Engineered Solutions program is geared toward providing customized fluid handling solutions that meet the aggressive timelines of your product development. That includes fast delivery of sample catalog valves from our comprehensive valve portfolio for quick evaluation. For those with very specific requirements, we have an iterative design cycle whereby Emerson product development engineers work directly with you to create customized fluid-handling components, modules and assemblies tailored to your unique application. These capabilities help you bring your new analytical instrument or medical device to market faster.

What's your challenge?



"More collaboration between device developers and their supply chain partners to explore how alternative designs and materials might alleviate some design complexity, enabling products to be manufactured faster and potentially more cost-effectively, with fewer overall inputs"

– MDDI - Medical Device and Diagnostic Industry, 2019

What's your opportunity?



An analytical instrument manufacturer designing a continuous chromatography machine needed a complex solution that integrated a large number of general service valves with Ethernet connectivity that would control several chromatography columns in a single instrument. Emerson quickly designed custom manifold assemblies integrating multiple fluid-handling products that met the requirements, optimized performance and removed the need for an instrument redesign.

Faster development



Industry expertise supports efficient development and manufacture of complex miniature fluid-handling solutions for analytical instruments and medical devices.



An extensive portfolio of 'standard catalog' valves allows fast delivery of initial samples, typically within just a couple of days, enabling evaluation to start quickly.

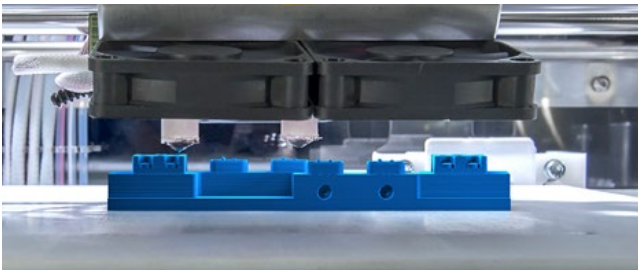

In-house 3D printing capabilities enable fast production of stereolithography (SLA) models for fit testing. Fully functional prototypes for beta testing are available in a matter of days.

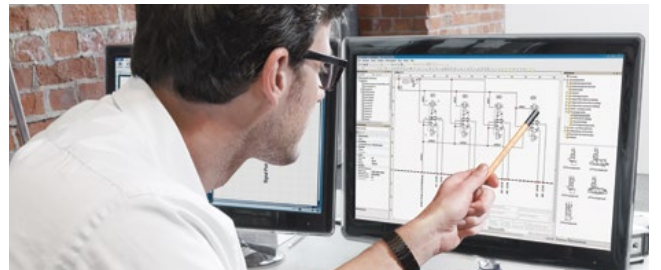

An iterative design process starts with identification of your specific application requirements and results in a fast fully-engineered solution.

Faster production, reduced complexity



Expert advice on appropriate fluidic path design for your specific product reduces design complexity, which supports more efficient manufacturing processes.



All customizations are designed for manufacturability, ensuring there are no issues when production is scaled up.

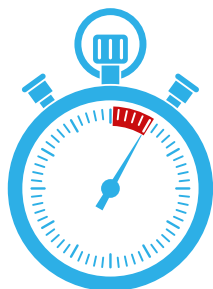

Extremely fast turnaround on customized fluid-handling components, modules and assemblies that meet your unique specifications and requirements.



Complete fluid handling solutions from a single provider help simplify and streamline the procurement process.



Need help to choose, implement and optimise the right solution for your application, visit [Emerson.com/rapid-engineered-solutions](https://www.emerson.com/rapid-engineered-solutions)



Enhance the PERFORMANCE of your device over its lifetime.

The performance and reliability of your analytical instrument or medical device over its lifecycle is essential for patient care and safety. Liquid handling solutions therefore must offer extended lifecycles, minimum maintenance and outstanding reliability. Your devices also need to be easy to install and maintain, contributing to lower lifecycle costs. Emerson's Rapid Engineered Solutions assist in simplifying your fluidic path designs to maximize efficiencies and reduce costs. Plug-and-play assemblies and modules help to simplify installation and maintenance. While a comprehensive portfolio of industry-proven valve technology and solutions enhance reliability, maximize device efficiency and help to extend equipment lifetime.

What's your challenge?



"Medical device companies are often met with challenges in their drive to cost-effectively design devices that respond to market dynamics or solve unmet medical needs for patients. It's critical to have a partner that can successfully counsel and support OEMs when a device requires a redesign or design alteration."
—Medical Design and Outsourcing, 2020

What's your opportunity?



A start-up company developing a low-cost respiratory ventilator targeted at developing countries turned to Emerson for support. The company was provided with extensive advice and technical support, a turnkey custom-built valve assembly to control the containment, mixing and distribution of air, and crucially, manufacturing support on a global basis.

Manufacturing efficiency



Emerson industry experts collaborate with your engineers to design products that are easier to manufacture and have lower operational costs.

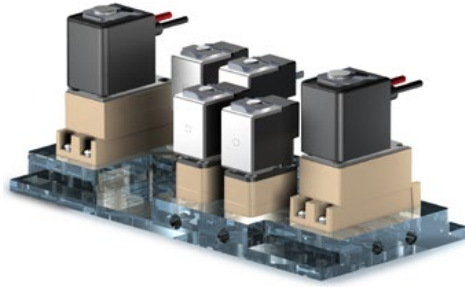

Plug-and-play assemblies and modules help to simplify installation time and costs during manufacturing.



Engineered solutions are manufactured in a Class 8 equivalent clean room environment to minimize contamination, preventing manufacturing rework.

Reduce operational costs



Industry-proven, reliable products are 100% factory-tested, minimizing product returns and maintenance costs.



Specify optional power-saving functions for improved energy efficiency.



Need help to choose, implement and optimise the right solution for your application, visit [Emerson.com/rapid-engineered-solutions](https://www.emerson.com/rapid-engineered-solutions)

Rapid Engineered Solutions: customized fluid-handling solutions for analytical instrumentation and medical devices



Emerson is a global automation leader, with key engineering and manufacturing support across the world. Our global presence and scale enables us to provide sustained local engagement, streamline processes and provide faster deliverables that help to increase your speed to market. Through superior customer engagement and collaboration, deep expertise across applications, and broad product offering, we can easily design a customized solution to even the most complex issue.

[Emerson.com/rapid-engineered-solutions](https://www.emerson.com/rapid-engineered-solutions)

Global presence with local support

- Global manufacturing, sales and technical support for all analytical and medical applications
- Technical support is provided by local experts and product specialists, trained in analytical and medical applications
- Dedicated prototype labs in the Americas, Europe and Asia
- Class 8 equivalent clean room manufacturing to eliminate any potential contamination
- In-house additive manufacturing capability

Application-specific support

- Clinical diagnostic instruments
- DNA sequencing and bioinstrumentation
- Hospital beds and therapeutic support surfaces
- Dental chairs and delivery systems
- Chromatographic analyzers
- Industrial liquid and gas monitoring instruments
- Patient monitoring devices
- Surgical fluid management instrumentation
- Sterilization equipment
- Oxygen therapy, respiratory and ventilation devices

Products and accessories

- Pinch, isolation, proportional and general purpose valves
- Manifolds and fittings
- Wire harness assemblies
- Sensors, filtration and regulator elements

Customized solutions

Oxygen Therapy

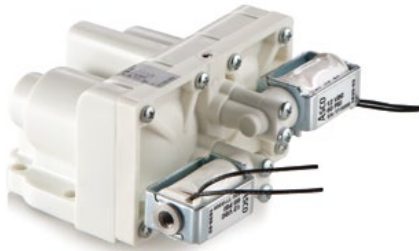

Customized ASCO RB Series valves control air flow through nitrogen-absorbing sieve-beds, providing purified oxygen to patients.

Therapeutic Support Surfaces



High-flow general service valves on a PBT manifold operate several individual air bladders for patient comfort.

Dialysis

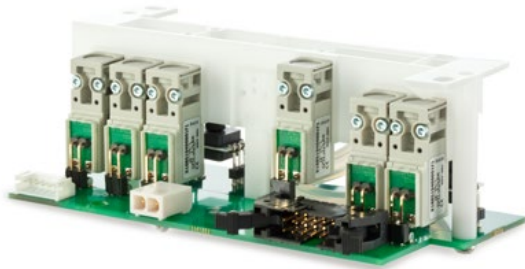

Unique assembly regulates liquid level in the blood chamber of a dialysis machine.

Clinical Diagnostics

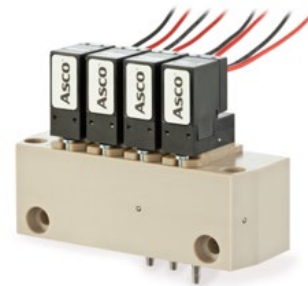

Custom PEEK manifold solution containing four ASCO Series 067 isolation valves for reagent control in immunoassay instrument.

Deep Vein Thrombosis

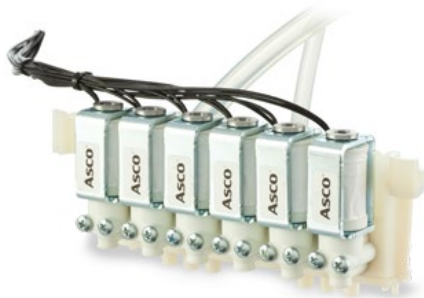

Six-station manifold to control inflation and deflation of pressure cuffs on deep vein thrombosis device.

Flow Cytometry



Layered acrylic manifold with liquid isolation valves to route samples and cleaners.

Dental Delivery Systems



Total solution for controlling air and water, as well as proportional control of rotary tools.

Hematology



Customized plug and play modules for controlling reagents, buffers, and washing solutions in a hematology instrument.

Solve your complex fluidic challenges and bring analytical instruments and medical devices to market faster.



ASCO™

Rapid Engineered Solutions helps to accelerate fluid handling design and engineering by providing valves and customized solutions to the exact specifications of your device at unprecedented speeds.

Visit us: [Emerson.com/rapid-engineered-solutions](https://emerson.com/rapid-engineered-solutions)
Your local contact: [Emerson.com/contactus](https://emerson.com/contactus)



[Emerson.com](https://emerson.com)



[Facebook.com/EmersonAutomationSolutions](https://facebook.com/EmersonAutomationSolutions)



[LinkedIn.com/company/Emerson-Automation-Solutions](https://linkedin.com/company/Emerson-Automation-Solutions)



[Twitter.com/EMR_Automation](https://twitter.com/EMR_Automation)

The Emerson logo is a trademark and service mark of Emerson Electric Co. Brand logotype are registered trademarks of one of the Emerson family of companies. All other marks are the property of their respective owners. © 2021 Emerson Electric Co. All rights reserved. BR000209ENUS-01_01-21



CONSIDER IT SOLVED™