

**Effective solutions for preventing
control valve noise.**

Noise-Attenuation Technologies for Control Valves
Your trusted source for proven noise-reduction solutions.



You need to decrease process variability while protecting equipment and the environment from excessive noise effects.

Valve and pipeline aerodynamic and liquid noise causes concern for plant operators and maintenance personnel because it can affect plant availability and profitability. High noise levels can induce safety concerns for plant personnel and can lead to equipment damage through vibration and process control issues. Populated areas are moving closer to processing plants and noise attenuation is crucial to avoid complaints and potential regulatory action.

“Just as sound can have negative effects on the human body, certain frequencies can play havoc on industrial equipment. When control valves are not selected appropriately, there is an increased risk for cavitation, which causes high noise and vibration levels, resulting in very rapid damage to the valve’s internals and/or the downstream piping.” –Valve Magazine



“Twenty-two million workers are exposed to potentially damaging noise at work each year. Last year, U.S. business paid more than \$1.5 million in penalties for not protecting workers from noise.” –United States Department of Labor

\$1.5M



“Valve noise must be managed, as it affects plant profitability. To effectively resolve noise, it’s imperative to treat it at the source or path that it travels—not just any fix will work.” –Severe Service Business Development Manager, Emerson





Instead of worrying about potential noise-related regulatory fines, what if you could focus your time on plant availability and profitability?

Emerson's noise-attenuation technologies can effectively help mitigate noise issues.

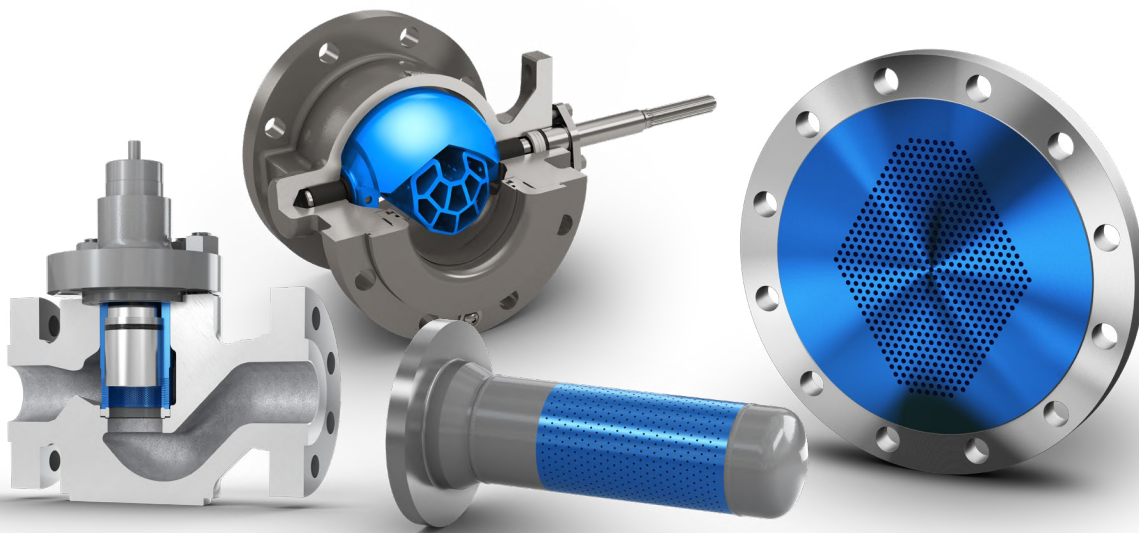

You get a larger selection of solutions from Emerson because our engineers and specialists analyze the major sources of valve noise and have determined not only how to predict noise, but also how to minimize it. We utilize the International Electrotechnical Commission (IEC) 60534-8-3 standard for noise prediction and are actively involved in improving it. We leverage our flow labs and testing facilities to provide accurate noise predictions, validated through tests in compliance with the IEC standard.



Consulting with Emerson technical experts on the optimal noise mitigation technologies can help you solve any existing or potential noise concerns.

Decrease equipment damage and maintain plant availability.

Minimize your risk for unplanned shutdowns due to assets damaged by the effects of valve noise. Aerodynamic and hydrodynamic noise can negatively impact your process and equipment.

Availability ► p5

Rely on trusted support throughout your plant's lifecycle.

"I called Emerson personnel on a Saturday, and they not only called me back, but also provided exceptional technical support—regarding a competitor's valve application."

– Instrument Technician Leader, Electric Power Company

Support ► p9

Minimize fenceline noise and protect your personnel.

Avoid costly fines and safeguard your employees and neighbors with proper noise-abatement technologies.

Protect ► p7

Your complete solution portfolio.

The source of process noise can be difficult to assess. Emerson studies process noise and tests solutions utilizing our state-of-the-art flow lab. We're able to provide a complete portfolio of products to assist you with the right solution for your plant.

Portfolio ► p11



Maintain plant AVAILABILITY by effectively controlling unwanted noise.

Noise can cause vibration in valves, piping, and other system elements. This vibration—caused by aerodynamic sound pressure, or cavitation—may eventually damage equipment and shorten operating life. When equipment deteriorates, your process isn't controlled properly and this directly impacts your plant availability and output. With more accurate noise predictions and engineered solutions, unwanted noise can be minimized, and in some cases, completely eliminated.

What's your challenge?



"Just as sound can have negative effects on the human body, certain frequencies can play havoc on industrial equipment. When control valves are not selected appropriately, there is an increased risk for cavitation, which causes high noise and vibration levels, resulting in very rapid damage to the valve's internals and/or the downstream piping."

—Valve Magazine

What's your opportunity?



Protect your process from upsets and minimize early degradation of your equipment with Emerson solutions. Through years of testing and design, our products and expertise offer options to fit your specific goals.

Maintain plant efficiency without the disturbance of noise effects

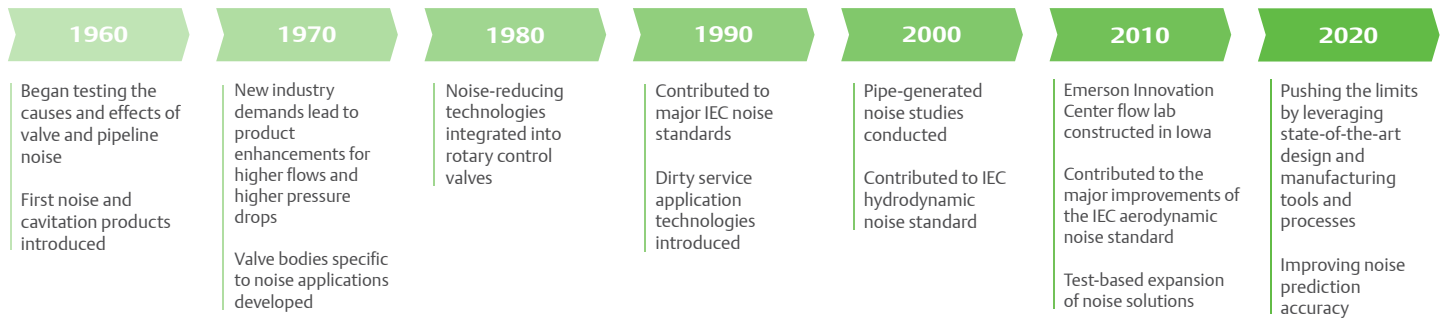

More Accurate Predictions for flow conditions that will likely produce high noise levels are possible because Emerson has made mitigating valve noise a priority for over fifty years. These pioneering efforts have been followed by years of continuous research and development. Therefore, virtually all forms of excessive noise can be avoided at the initial design phase of a project with proper consideration of service conditions.

Reduce the risk of damaging equipment

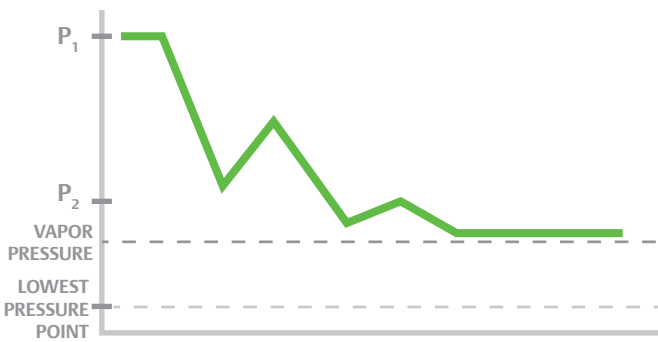

Cavitation Prevention is possible as the liquid undergoes a portion of the total pressure drop in each stage. This prevents the liquid in any stage from falling to or below its vapor pressure, avoiding cavitation.

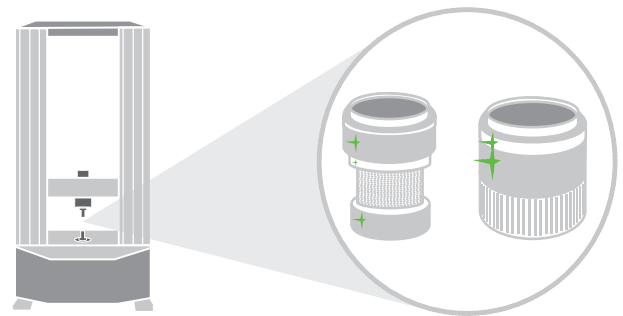

Long Trim Life is possible due to the hardened material that we specify as standard. We test our materials, utilizing a Tinius Olsen testing machine, to ensure exceptional wear resistance and have established these material standards globally.

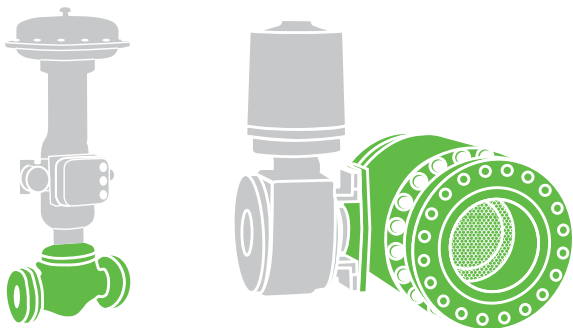

Specially Designed Valves for your specific application prevents the threat of assembly and piping damage. A single product design is not sufficient for the wide variation of applications across numerous process industries, so Emerson uses multiple approaches and unique designs or configurations to address your application-specific needs.

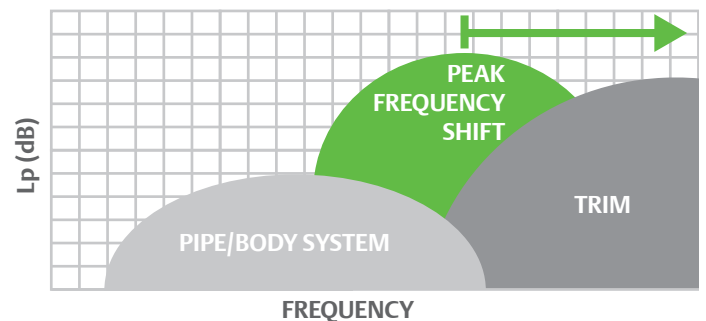

Frequency Spectrum Shifting reduces strain and acoustic energy in piping by exploiting the natural damping of high frequency acoustic waves. Piping transmission loss is maximized to reduce radiated aerodynamic noise.



To learn more about our noise-attenuation technologies, visit [Emerson.com](https://www.emerson.com)



PROTECT your personnel and surrounding environment from excessive noise risks.

High pressure drops and high mass flows involving liquids, gases, vapors, or steam can lead to unwanted and dangerous noise levels. Allowing this noise to continue puts you at risk of fenceline noise regulation fines or potential employee hearing loss. You need trusted and tested products to avoid the harm caused by valve noise—mitigate your risk by choosing Emerson products.

What's your challenge?



"Twenty-two million workers are exposed to potentially damaging noise at work each year. Last year, U.S. business paid more than \$1.5 million in penalties for not protecting workers from noise."
– United States Department of Labor

What's your opportunity?



Emerson utilizes IEC 60534-8-3 for noise prediction and product testing and is actively involved in developing this noise standard. You can have confidence that our products will solve your noise issues.

Meet environmental process noise regulations

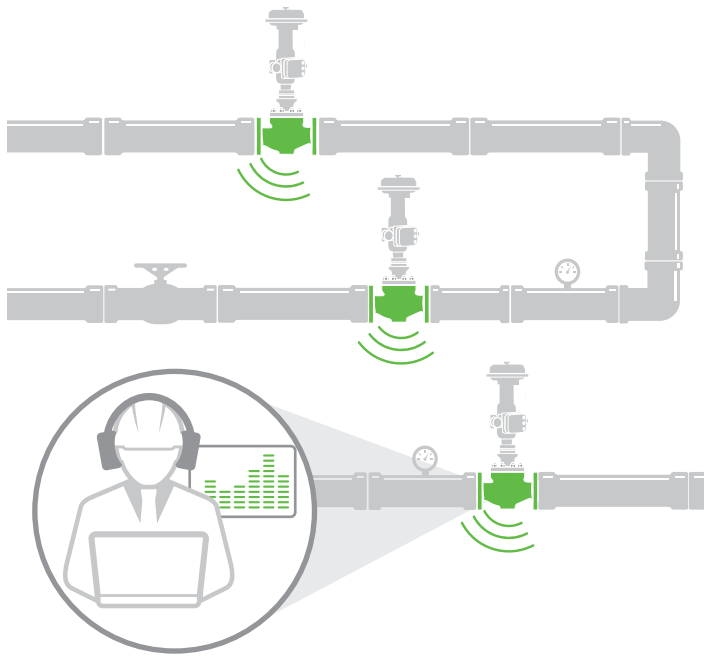

Proper Valve Sizing is critical for controlling valve noise. An inappropriately sized valve can introduce noise issues. We've standardized our valve sizing techniques and selection criteria to account for all factors that contribute to valve noise, so you can trust that our products will work in your plant, as advertised.

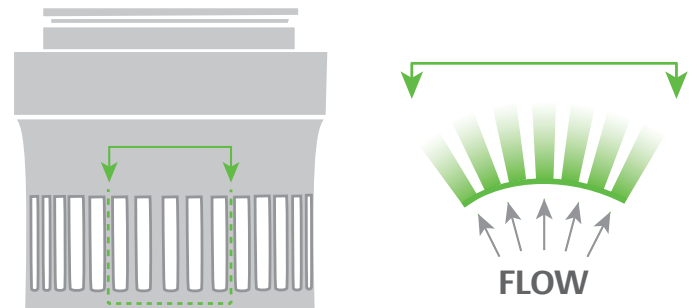

Exit Jet Independence is crucial for avoiding jet coalescence, which will lead to additional noise. All Emerson noise technologies are designed with this critical factor as standard.

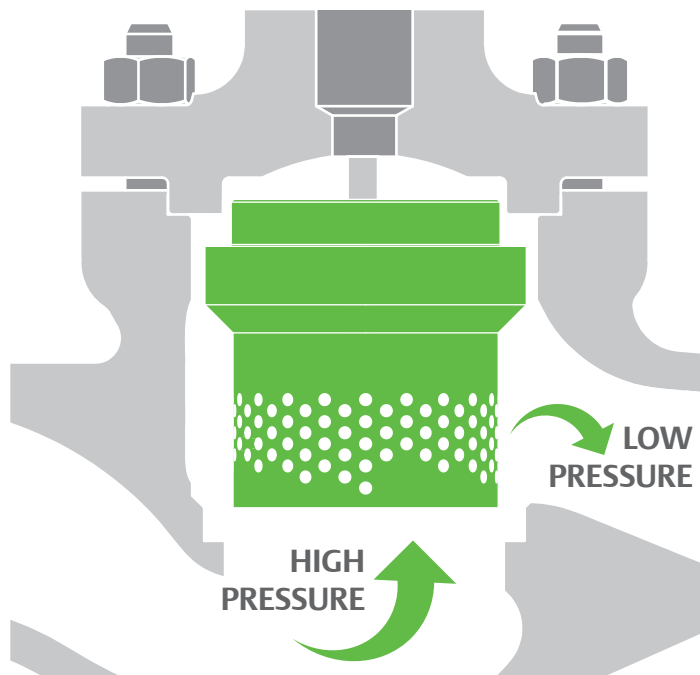

Pressure Management utilizes the expanding area principle to allow for volumetric expansion of depressurizing gas and safe pressure reduction of potentially cavitation liquids.

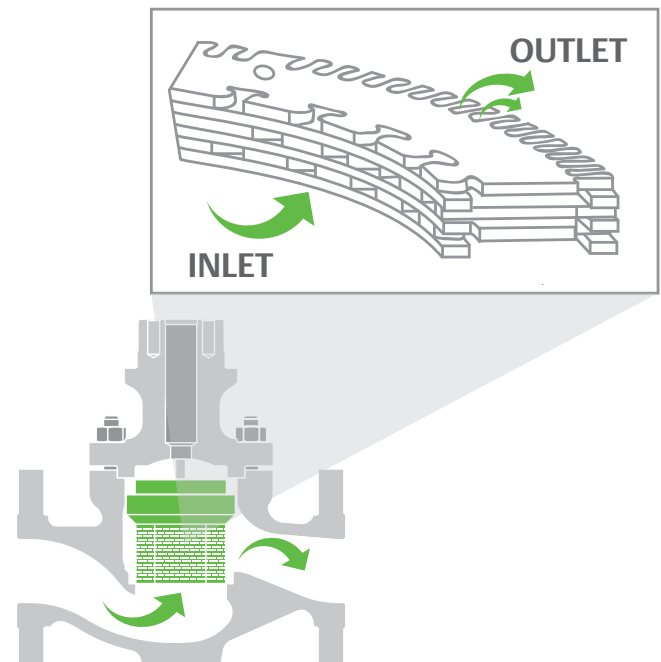

Unique Flow Passage Shapes reduce turbulence to minimize shock-associated noise and place turbulent shear layers away from solid boundaries to reduce noise. The multi-stage pressure reduction, utilized with sound engineering principles, controls jet size, formation, interaction, and accommodates fluid expansion.



To learn more about our noise-attenuation technologies, visit [Emerson.com](https://www.emerson.com)



Complete SUPPORT throughout the lifecycle of your plant.

Unplanned shutdowns due to noise challenges can cost you thousands—if not millions—in lost production and fines. Emerson’s local sales and support resources are able to consider both the flow requirements and the noise requirements for your particular application. They’re able to tailor alternative recommendations from our complete line of products and offer you the best engineered solution. Through extensive research and engineering, Emerson’s support and service team can get your plant back up and running and help you address your noise concerns.

What’s your challenge?



“Valve noise must be managed, as it affects plant profitability. To effectively resolve noise, it’s imperative to treat it at the source or path that it travels—not just any fix will work.” – Severe Service Business Development Manager, Emerson

What’s your opportunity?



When you partner with Emerson, you’ll have support from technical experts who can properly identify your noise source and offer a plethora of noise-attenuation solutions to help keep your process running.

Your trusted advisor in instrument and valve reliability

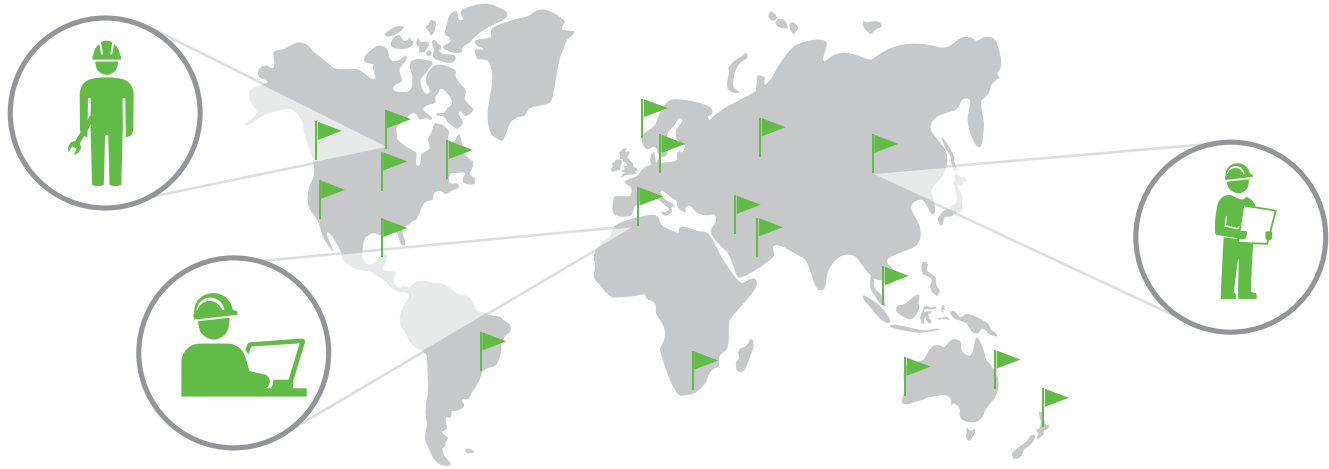

Worldwide Support Network of sales offices and service and support centers are available where and when you need them. With 24/7/365 after-hours service coverage and factory trained and certified technicians, Emerson is equipped to provide maintenance, reliability, and performance services to keep your plant up and running. ► [Contact us](#)

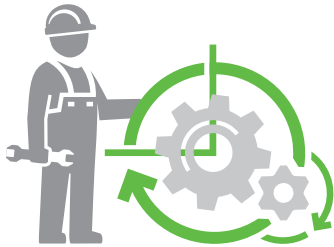

Shutdown, Turnaround, and Outage Planning performed by certified technicians help you optimize and extend your plant's lifecycle. Plus, we're available to you 24 hours a day, seven days a week during the course of an outage.

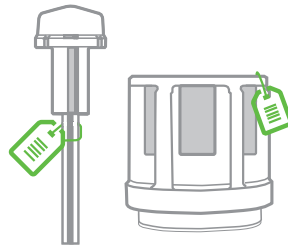

Original Equipment Manufacturer Parts help you maintain plant safety and integrity. Our genuine parts are commissioned and verified to give you the confidence that your repairs will last.

PLANTWEB



Valve Connected Services are a part of the Plantweb™ digital ecosystem and provide the ability to gather and aggregate diagnostic data across a single site and multiple sites across the globe. Emerson's certified analysts will interpret positioner data to look for patterns of systemic degradation and provide recommended actions to minimize downtime.

The right training, where and when you need it

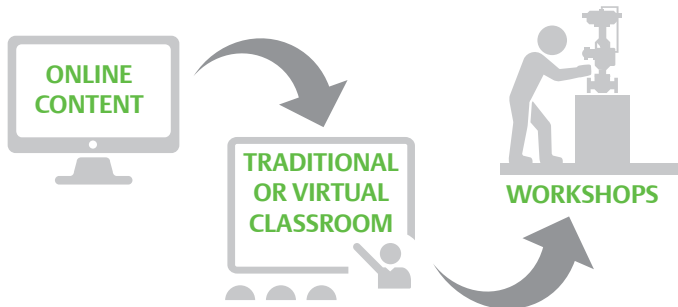

Flexible Courses are offered through our regional training centers, locally or at your facility, via the web utilizing eLearning, virtual classroom, traditional classroom, or through a blended learning method combining any or all of these options.



International Association for Continuing Education and Training Certification means our instructors comply with the standards of excellence for instructional practices and Emerson is an authorized and accredited provider.



To learn more about our noise-attenuation technologies, visit Emerson.com

A complete noise solution portfolio from Emerson.



Fisher™ Silencers

WhisperTube Modal Attenuator

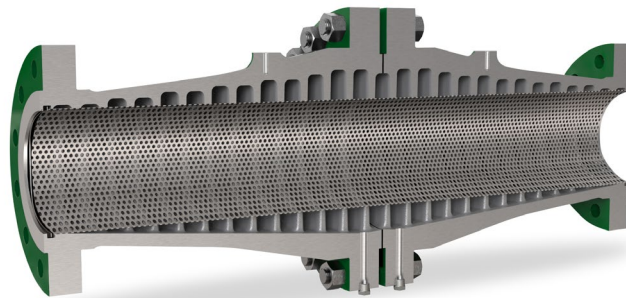

- Offers full bore aerodynamic noise reduction for all sources upstream, with no impact on process flow

Fisher™ Inline Diffusers

6010 Inline Diffuser

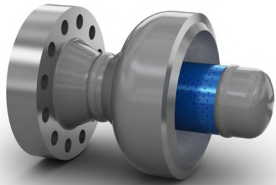

- Places backpressure on the valve, thereby reducing the turbulence and pressure drop across the valve

6011 Pipe-Style Inline Diffuser

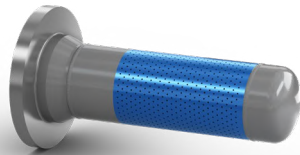

- Used in conjunction with a Whisper Trim™ cage, divides the overall pressure drop into two stages

Vent Diffuser



- Divides the total pressure drop with the valve, quieting both the valve and the vent

Whisper Disk™ Inline Diffuser

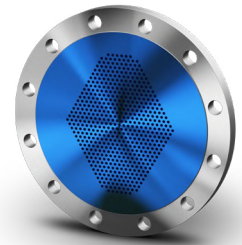

- Installed downstream of the valve and places backpressure on the valve to reduce damaging noise and vibration

Fisher™ Control Valve Trims

Whisper™ NXV Trim

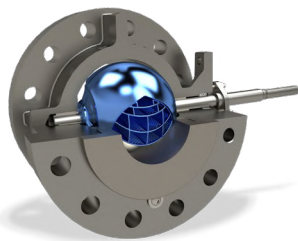

- Up to 20 dBA noise reduction - Trim geometry reduces turbulence, shifts frequencies, and controls noise throughout the ball's rotation

Whisper™ NXG Trim



- Up to 30 dBA noise reduction - Optimized design with maximized flow efficiency provides 20% more flow capacity than previously possible

WhisperFlo™ Trim

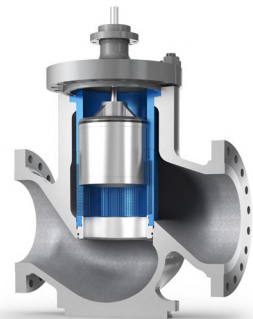

- Up to 40 dBA noise reduction - Multi-path, multi-stage trim that delivers predicted noise levels consistently

Whisper Trim™ III Cage

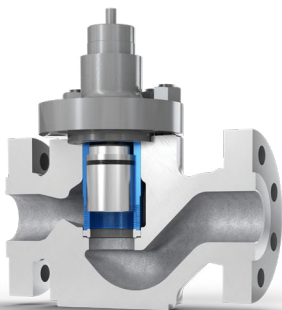

- Up to 30 dBA noise reduction - Multiple passages break up the large turbulent stream into many small, independent jets to quiet noise

Whisper Trim™ I Cage



- Up to 18 dBA noise reduction - Designed with small vertical slots around the circumference of the cage to reduce turbulence within the flow passages

V260 & V280 Valves with Aerodome & Hydrodome Attenuators

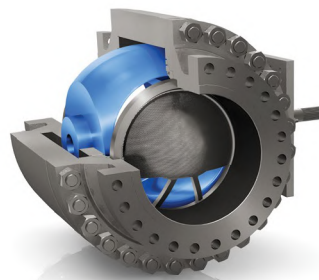

- An integral drilled-hole attenuator controls noise and vibration from high-pressure drop liquids and gases

Vee-Ball™ Valve with Rotary Attenuator

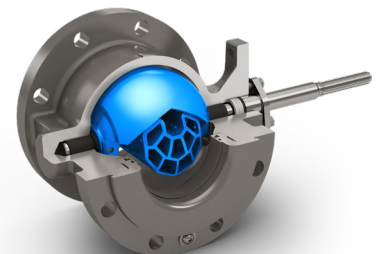

- Features an attenuator welded on the back of the V-notch ball, which separates the flow into multiple smaller jets

Cavitrol™ Hex Trim



- For severe service liquid applications, reduce noise and cavitation effects that cause pipeline vibration

GX Valve with Cavitrol™ III Trim

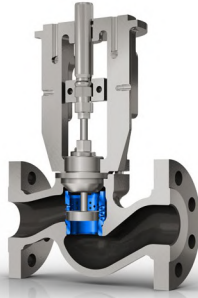

- Proprietary drilled-hole shape and spacing reduces and isolates cavitation, lowering hydrodynamic noise and vibration

Cavitrol™ III Micro-Flat Trim



- Cage, plug, and seat ring are designed and manufactured as a unit, offering cavitation control for high pressure drops at very low flow rates

Cavitrol™ III Trim

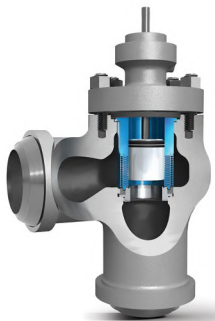

- Engineered flow passages provide sustained operation through pressure staging while maintaining flow efficiency

Micro-Flat Trim



- Utilizes a cavitation-control mechanism consisting of special flow paths to prevent impingement on critical trim components

461 Sweep-Flo Angle Valve



- Is self-cleaning with an expanded outlet that has carefully designed flow paths to control impingement

NotchFlo™ DST Control Valve

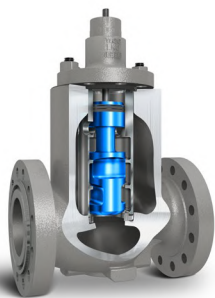

- Uses a series of large area flow restrictions and expansions to control the pressure drop of the fluid while allowing particulate to pass

Dirty Service Trim

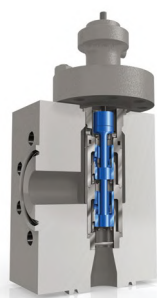

- Combined axial and radial flow paths feature large openings allowing particulate to pass through the valve, minimizing plugging and erosion

CAV4 Control Valve with Cavitrol™ IV Trim

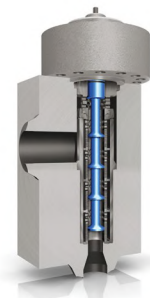

- Each stage has a successively larger flow area, which allows for the pressure drop to be taken in the initial stages and limits cavity formation

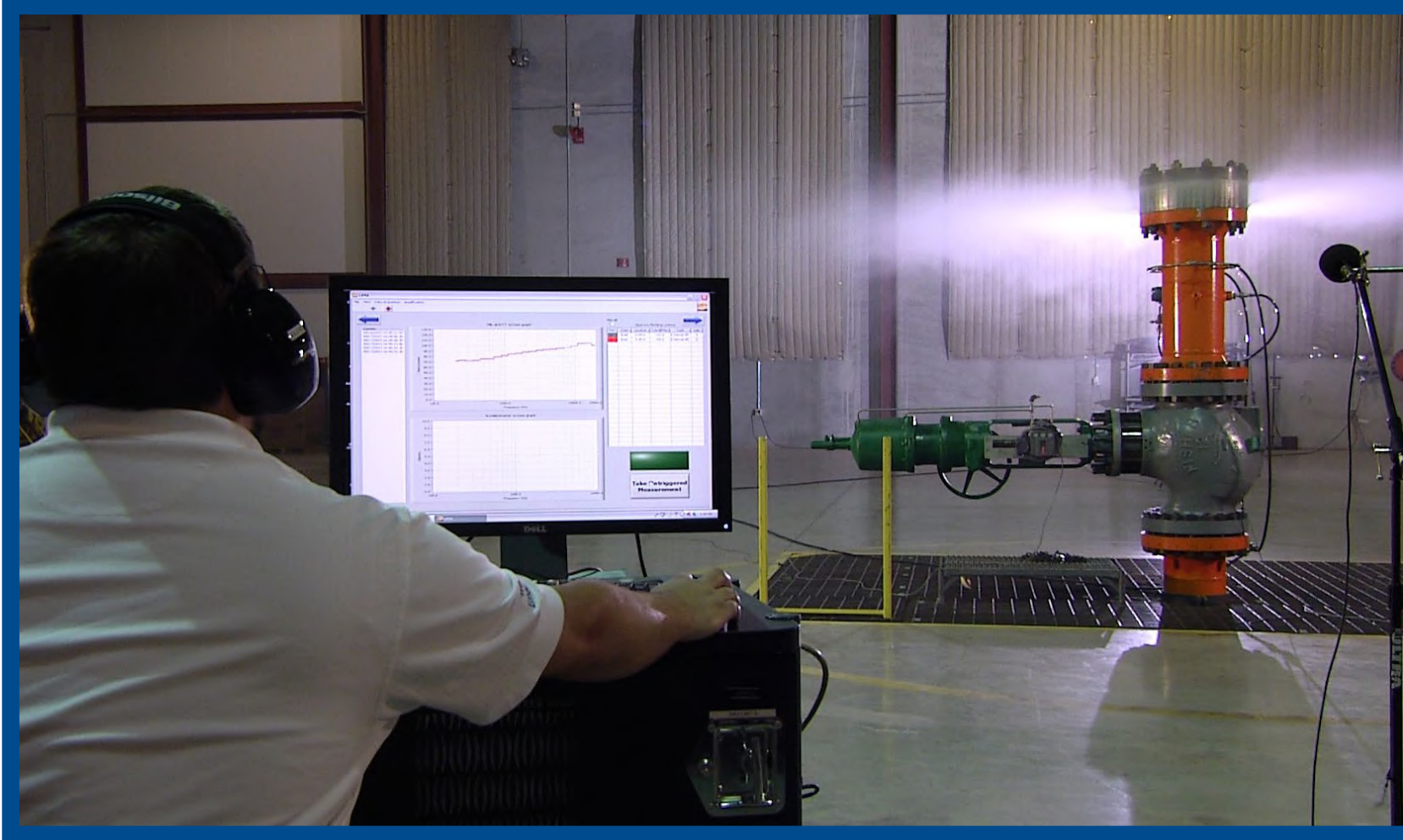

Learn More

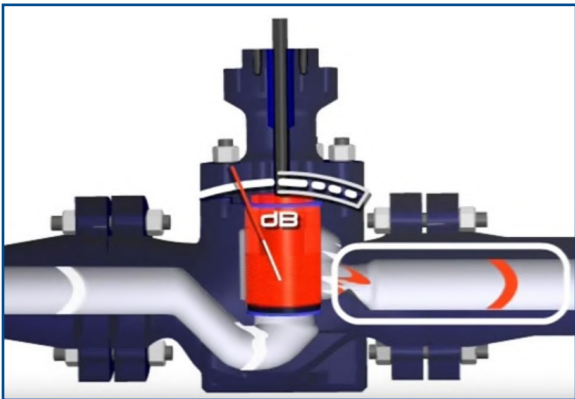

Noise Abatement

Our engineers analyze acoustic sources—from valves and trim to diffusers and spargers—so you don't risk worker safety, costly fines, or operating restrictions.

▶ [Watch Animation](#)

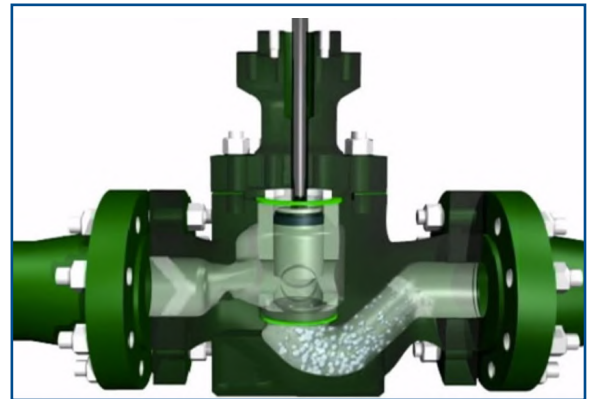

Cavitation Control

Ensuring tight tolerances, making suitable material options available, and correctly staging pressure drops are all ways our products can help you prevent cavitation issues. ▶ [Watch Animation](#)



To learn more about our noise-attenuation technologies, visit [Emerson.com](https://www.emerson.com)

Proven noise treatment methods and prediction techniques from Emerson.

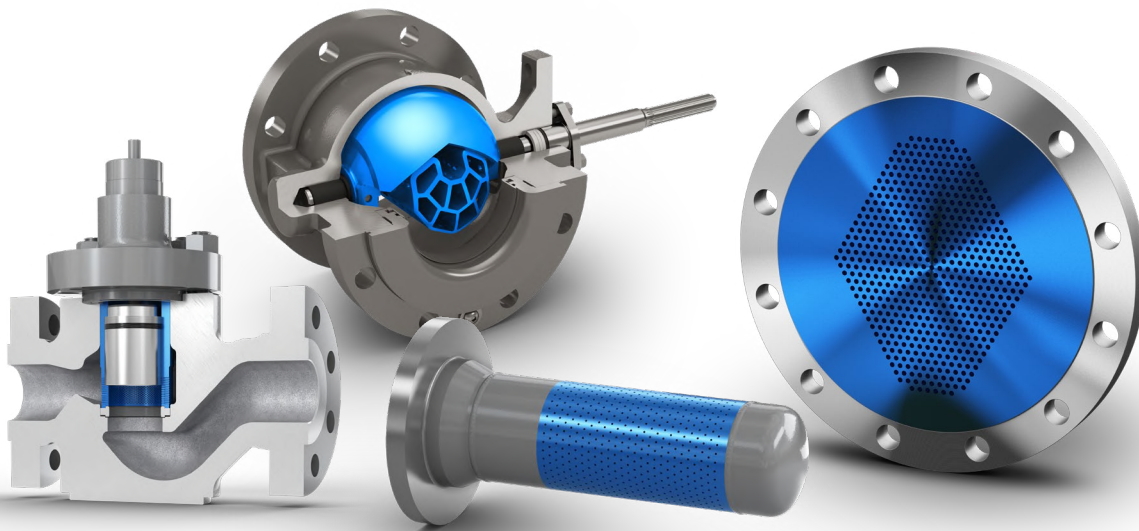

Emerson

Marshalltown, Iowa, 50158 USA
Sorocaba, 18087 Brazil
Cernay, 68700 France
Dubai, United Arab Emirates
Singapore 128461 Singapore



Fisher.com



Facebook.com/FisherValves



LinkedIn.com/groups/Fisher-3941826



Twitter.com/FisherValves

© 2024, 2018 Fisher Controls International LLC. All rights reserved. Plantweb, Whisper Disk, Whisper Trim, WhisperFlo, Cavitrol, Vee-Ball, NotchFlo, and Fisher are marks owned by one of the companies in the Emerson business unit of Emerson Electric Co. Emerson and the Emerson logo are trademarks and service marks of Emerson Electric Co. All other marks are the property of their respective owners. The contents of this publication are presented for informational purposes only, and while every effort has been made to ensure their accuracy, they are not to be construed as warranties or guarantees, express or implied, regarding the products or services described herein or their use or applicability. All sales are governed by our terms and conditions, which are available upon request. We reserve the right to modify or improve the designs or specifications of such products at any time without notice. Neither Emerson, nor any of its affiliated entities assume responsibility for the selection, use, or maintenance of any product. Responsibility for proper selection, use, and maintenance of any product remains solely with the purchaser and end user.
D351989X012 | Jul24



EMERSON™