











Approvals Document - Class Division Rosemount™ 8750W Magnetic Flowmeter



Rosemount™ 8750W Magnetic Flowmeter Platform

Order Code	8750W Magnetic Flowmeter Platform Rating	Region	Agency	Certification Number
-	Ordinary Locations*	USA, Canada, EU, CU**	CSA, EAC	80102916
Z1	ATEX Non-Sparking or Increased Safety and Dust for Non-Flammable Fluids	EU	DEKRA	15ATEX0003 X
ND	ATEX Dust	EU	DEKRA	15ATEX0003 X
Z2	InMetro Non-Sparking and Dust for Non-Flammable Fluids	Brazil	DNV GL - INMETRO	DNV 18.0082 X
Z3	NEPSI Non-Sparking and Dust for Non-Flammable Fluids	China	NEPSI	GYJ20.1283X
Z5	DIP (Dust-Ignitionproof) Class II and III, Div 1. Non-Incendive, Class I Div 2 for Non-Flammable Fluids	USA	CSA	80102916
Z6	DIP (Dust-Ignitionproof) Class II and III, Div 1. Non-Incendive, Class I Div 2 for Non-Flammable Fluids	USA & Canada	CSA	80102916
ZC	North America Approvals, Class I Zone 2, Class II Zone 22	USA & Canada	CSA	80102916
Z7	IECEX Non-Sparking or Increased Safety and Dust for Non-Flammable Fluids	Global	DEKRA	IECEX DEK 15.0001X
NF	IECEX Dust	Global	DEKRA	IECEX DEK 15.0001X
Z9	KTL Non-Sparking and Dust for Non-Flammable Fluids	Korea	KTL	***
*Complies with only the local country Product safety, Electromagnetic, Pressure and other applicable regulations. Cannot be used in a classified or zoned hazardous location environment.				
** Customs Union (Russia, Belarus and Kazakhstan)				
*** Future				

Approval Markings and Logos

Symbol	Marking or Symbol Name	Region	Meaning of Marking or Symbol
	CE	European Union	Compliance with all applicable European Union Directives.
	ATEX	European Union	Compliance with Equipment and Protective systems intended for use in Potentially Explosive Atmospheres directive (ATEX) (2014/34/EU)
	C-tick	Australia	Compliance with Australian applicable electromagnetic compatibility standards
	CSA	US = United States C = Canada	Indicates that the product was tested and has met the applicable certification requirements for the noted countries.
	Eurasian Conformity (EAC)	Eurasian Customs Union (Russia, Belarus and Kazakhstan)	Compliance with all applicable technical regulations of the EAC Customs Union
	Russian Pattern Approval Certificate	Russia	Indicates compliance of measuring instruments with the approved metrological and technical characteristics.
	DNV GL - INMETRO	Brazil	Compliance with all applicable technical regulations of Brazil.
	NEPSI	China	Compliance with all applicable technical regulations of China.
	KTL	Korea	Compliance with all applicable technical regulations of Korea.

Ordinary Location labels will be marked with CE, C-tick, CSA and EAC logos.

European Directive Information

The most recent revision of the EU Declaration of Conformity can be found at www.emerson.com.

Certifications

Canadian Standards Association (CSA)

Ordinary Location Certification

The transmitter and flowtube have been examined and tested to determine that the design meets basic electrical, mechanical, and fire protection requirements by CSA, a nationally recognized testing laboratory (NRTL) as accredited by the Federal Occupational Safety and Health Administration (OSHA).

CLASS 2258 02 - PROCESS CONTROL EQUIPMENT - For Hazardous Locations – To Canadian Requirements.

Z6, Z5	Class I, Division 2, Groups A, B, C and D; T4 (Non-Incendive)
ZC	Ex nA [ic] IIC T4 Gc (Transmitter – DC Powered Only)
ZC	Ex ec [ic] IIC T4 Gc (Transmitter – DC Powered Only)
ZC	Ex nA ic [ic] IIC T4 Gc (8750WDMW Transmitter – DC Powered Only)
ZC	Ex ec ic [ic] IIC T4 Gc (8750WDMW Transmitter – DC Powered Only)
ZC	Ex nA ic IIC T5...T4 Gc (Flow Tube)
ZC	Ex ec ic IIC T5...T4 Gc (Flow Tube)
Z6, Z5	Class II, Division 1, Groups E, F and G, T5; Class III (Dust Ignition Proof)
ZC	Ex tc IIIC T80 °C...T130 °C Dc (Transmitter and Flow Tube)
ZC	Ex tc IIIC T80 °C Dc (8750WDMW Transmitter)
ZC	Ex tc [ic] IIIC T80 °C...T130°C Dc (8750WDMT or WDMR Transmitter)
ZC	Ex tc [ic] IIIC T80 °C Dc (8750WDMW Transmitter)

CLASS 2258 82 - PROCESS CONTROL EQUIPMENT - For Hazardous Locations –To US Requirements

Z6, Z5	Class I, Division 2, Groups A, B, C and D; T4 (Non-Incendive)
ZC	Class I, Zone 2, AEx nA [ic] IIC T4 Gc (Transmitter – DC Powered Only)
ZC	Class I, Zone 2, AEx ec [ic] IIC T4 Gc (Transmitter – DC Powered Only)
ZC	Class I, Zone 2, AEx nA ic [ic] IIC T4 Gc (8750WDMW Transmitter – DC Powered Only)
ZC	Class I, Zone 2, AEx ec ic [ic] IIC T4 Gc (8750WDMW Transmitter – DC Powered Only)
ZC	Class I, Zone 2, AEx nA ic IIC T5...T4 Gc (Flow Tube)
ZC	Class I, Zone 2, AEx ec ic IIC T5...T4 Gc (Flow Tube)
Z6, Z5	Class II, Division 1, Groups E, F and G, T5; Class III (Dust Ignition Proof)
ZC	Class II, Zone 22, AEx tc IIIC T80°C... 130°C Dc (Transmitter and Flow Tube)
ZC	Class II, Zone 22, AEx tc IIIC T80 °C Dc (8750WDMW Transmitter)
ZC	Class II, Zone 22, AEx tc [ic] IIIC T80 °C...T130°C Dc (8750WDMT or WDMR Transmitter)
ZC	Class II, Zone 22, AEx tc [ic] IIIC T80 °C Dc (8750WDMW Transmitter)

8750W Magnetic Flowtube and Transmitter

Z6, Z5	All Flowtubes and Integral or Remote Mount Transmitters (Transmitter mount codes T or R) Non-Incendive for Class I, Division 2, Groups ABCD: T4 Dust-Ignition Proof for Class II/III, Division 1, Groups EFG: T5 -29°C ≤ Ta ≤ 60°C Enclosure Type 4X, IP66/68 (IP68 flowtube only with Remote mount transmitter) Install per drawing 8750W-1051
--------	--

8750W Magnetic Flowtube and Transmitter

Z6, Z5	All Flowtubes and Wall Mount Transmitter (Transmitter mount code W) Non-Incendive for Class I, Division 2, Groups ABCD: T4 Dust-Ignition Proof for Class II/III, Division 1, Groups EFG: T4 -29°C ≤ Ta ≤ 40°C Enclosure Type 4X, IP66/68/69K (IP68 flowtube only; IP69K Transmitter mount code WDMW) Install per drawing 8750W-1051
--------	--

Special Conditions of Safe Use for Class/Division

1. Flow tube to be used only in a non-flammable process.

Special Conditions for Safe Use (X) for Class Zone:

1. When "Special Paint Systems" are applied, instructions for safe use regarding potential electrostatic charging hazard have to be followed.
2. Conduit entries must be installed to maintain the enclosure ingress rating of IP66 (Transmitter and Flow Tube), IP68 (Flow Tube) or IP69K (Flow Tube or 8750W...W transmitter) as applicable.
3. Terminals for the output signals of the Magnetic Flow Transmitters, cannot withstand the 500 V isolation test between signal and ground, due to integral transient protection. This must be taken into account upon installation.
4. When utilizing the keypad of Magnetic Flow Transmitter Model 8750W...W, instructions for safe use regarding potential electrostatic charging hazard have to be followed.

Rosemount 8750W Magnetic Flowmeter Platform IECEX & ATEX Approval Document

20 September 2020,
8750W-AP02, Rev AD

1. Equipment Markings – See section VI in the tables on the following pages
 - a. Type Examination Certificate (ATEX): DEKRA 15ATEX0003 X and Annex 1
 - b. Certificate of Conformity (IECEX): IECEX DEK 15.0001X and Annex 1
2. Required Documentation:
 - a. 8750W-2052 Installation Drawing Model 8750W ATEX/IECEX Hazardous (Ex) Locations
3. Referenced Documentation:
 - a. 00825-0X00-4444.pdf, Transmitter Quick Installation Guide (Where X = Communications Protocol Code)
 - b. 00825-0300-4750.pdf, Sensor Quick Installation Guide
4. The Required and Referenced Documents listed above address the following items:
 - a. Instructions for safety i.e.
 - i. Putting into service
 - ii. Use
 - iii. Assembling and dismantling
 - iv. Maintenance, overhaul and repair
 - v. Installation
 - vi. Adjustment
 - b. Where necessary, training instructions
 - c. Details which allow a decision to be made as to whether the equipment can be used safely in the intended area under the expected operating conditions
 - d. Electrical parameters, maximum surface temperatures and other limit values
 - i. Electrical –
 1. See document 8750W-2052

Rosemount 8750W Flow Transmitter	
<i>Power input</i>	90 - 250VAC, 0.45A, 40VA 12 - 42VDC, 1.2A, 15W
<i>Pulsed circuit</i>	<i>Internally powered (Active): Outputs up to 12VDC, 12.1mA, 73mW</i> <i>Externally powered (Passive): Input up to 28VDC, 100mA, 1W</i>
<i>4-20mA output circuit</i>	<i>Internally Powered (Active): Outputs up to 25mA, 24VDC, 600mW</i> <i>Externally Powered (Passive): Input up to 25mA, 30VDC, 750mW</i>
<i>MODBUS</i>	<i>Internally Powered (Active): Outputs up to 100mA, 3.3VDC, 100mW</i>
<i>Fieldbus</i>	<i>Externally Powered (Passive): 9-32VDC,</i>
<i>Profibus</i>	<i>Externally Powered (Passive): 9-32VDC,</i>
<i>Um</i>	250V
<i>Coil excitation output</i>	500mA, 40V max, 9W max
Rosemount 8750W Flowtube⁽¹⁾	
<i>Coil excitation input</i>	500mA, 40V max, 20W max
<i>Electrode circuit</i>	5V, 200µA, 1mW

(1) Provided by the transmitter

- e. Special Conditions for Safe Use (X):
 - i. Terminals for the output signals of the Magnetic Flow Transmitters, cannot withstand the 500 V isolation test between signal and ground, due to integral transient protection. This must be taken into account upon installation.
 - ii. When utilizing the keypad of Magnetic Flow Transmitter Model 8750W...W, instructions for safe use regarding potential electrostatic charging hazard have to be followed.
 - iii. Models marked with ESD warning label, do not rub surface with a dry cloth or clean with solvents to avoid electrostatic charge build-up.
 - iv. Conduit entries must be installed to maintain the enclosure ingress rating of IP66 (Transmitter and Flow Tube), IP68 (Flow Tube) or IP69K (Flow Tube or 8750W...W transmitter) as applicable.
- f. Where necessary, the essential characteristics of tools which may be fitted to the equipment
 - i. No proprietary tools required.
- g. List of the standards, including the issue date, with which the equipment is declared to comply:
 - i. ATEX - EN IEC 60079-0 : 2018 , EN 60079-7: 2015+A1:2018 (Ed 5.1), EN 60079-11 : 2012, EN 60079-15 : 2010, EN 60079-31 : 2014
 - ii. IECEx - IEC 60079-0: 2017, IEC 60079-7: 2015+A1: 2017 (Ed 5.1), IEC 60079-11: 2011, IEC 60079-15: 2017, IEC 60079-31: 2013
- h. Supply wire requirements;
Use 10 - 18 AWG wire rated for the proper temperature of the application. For wire 10 - 14 AWG use lugs or other appropriate connectors. For connections in ambient temperatures above 122°F (50 °C), use a wire rated for 194 °F (90 °C).
- i. Contact address; Emerson - Rosemount, Micro Motion Inc
12001 Technology Drive
Eden Prairie, MN 55344, United States of America

Rosemount 8750W Magnetic Flowmeter Platform IECEX & ATEX Approval Document

20 September 2020,
8750W-AP02, Rev AD

Nomenclature Magnetic Flow Meter System Model 8750W and electrical data

8750W ... R 1 A 2 ... F 005 ... Z1 ... M4 ... AX ... V1 ... R50
 I II III IV V VI VII VIII IX X XI XII

Designation	Explanation	Value	Explanation
I	Model	8750W	Flow Meter System Model 8750W
II	Transmitter Mount	R T W	Remote Mount Integral Mount Wall Mount
III	Transmitter Power Supply	1 2	AC (90 - 250 Vac, 50 / 60 Hz), not for Ex nA or Ex ec DC (12 - 42 Vdc)
IV	Transmitter Outputs	A M F P 0	Non-I.S.: 4 - 20 mA with digital HART Protocol & Scalable Pulse Output Non-I.S.: Modbus RS-485 I.S.: Foundation Fieldbus / FISCO Intrinsically Safe & Intrinsically Safe Scalable Pulse Output I.S.: Profibus & Intrinsically Safe Scalable Pulse Output Spare Flow Tube, no Transmitter
V	Conduit Entries	1 2 4 5	1/2-14 NPT female CM20, M20 female 1/2-14 NPT female, 8750W...R / T only CM20, M20 female, 8750W...R / T only
VI	Electrode Type	A, B, E, F 0	Seal of electrodes comply with IEC 61010-1. Spare Transmitter, No Flow Tube
VII	Line Size	005 to 480 000	1/2" NPS (15 mm) to 48" NPS (1200 mm) Spare Transmitter, no Flow Tube

Continued on next page

Rosemount 8750W Magnetic Flowmeter Platform IECEX & ATEX Approval Document

20 September 2020,
8750W-AP02, Rev AD

Nomenclature Magnetic Flow Meter System Model 8750W and electrical data (continued)

8750W ... R 1 A 2 ... F 005 ... Z1 ... M4 ... AX ... V1 ... R50
 I II III IV V VI VII VIII IX X XI XII

Designation	Explanation	Value	Explanation
VIII	Safety Approvals	Z1 ATEX	Transmitter Models 8750W...R and 8750W...T: ⓧ II 3 G Ex nA [ic] IIC T4 Gc * ⓧ II 3 G Ex ec [ic] IIC T4 Gc * ⓧ II 3 D Ex tc IIIC T80 °C...T130 °C Dc ** Transmitter Models 8750W...R and 8750W...T: ⓧ II 3 G Ex nA [ic] IIC T4 Gc * ⓧ II 3 G Ex ec [ic] IIC T4 Gc * ⓧ II 3 D Ex tc [ic] IIIC T80 °C...T130 °C Dc **, *** Transmitter Model 8750W...W: ⓧ II 3 G Ex nA ic [ic] IIC T4 Gc * ⓧ II 3 G Ex ec ic [ic] IIC T4 Gc * ⓧ II 3 D Ex tc IIIC T80 °C Dc ** Transmitter Model 8750W...W: ⓧ II 3 G Ex nA ic [ic] IIC T4 Gc * ⓧ II 3 G Ex ec ic [ic] IIC T4 Gc * ⓧ II 3 D Ex tc [ic] IIIC T80 °C Dc **, *** Flow Tube: ⓧ II 3 G Ex nA ic IIC T5...T4 Gc ⓧ II 3 G Ex ec ic IIC T5...T4 Gc ⓧ II 3 D Ex tc IIIC T80 °C...T130 °C Dc
		Z7 / Z9 IECEX	Transmitter Models 8750W...R and 8750W...T: Ex nA [ic] IIC T4 Gc * Ex ec [ic] IIC T4 Gc * Ex tc IIIC T80 °C...T130 °C Dc ** Transmitter Models 8750W...R and 8750W...T: Ex nA [ic] IIC T4 Gc * Ex ec [ic] IIC T4 Gc * Ex tc [ic] IIIC T80 °C...T130 °C Dc **, *** Transmitter Model 8750W...W: Ex nA ic [ic] IIC T4 Gc * Ex ec ic [ic] IIC T4 Gc * Ex tc IIIC T80 °C Dc ** Transmitter Model 8750W...W: Ex nA ic [ic] IIC T4 Gc * Ex ec ic [ic] IIC T4 Gc * Ex tc [ic] IIIC T80 °C Dc **, *** Flow Tube: Ex nA ic IIC T5...T4 Gc Ex ec ic IIC T5...T4 Gc Ex tc IIIC T80 °C...T130 °C Dc
		ND ATEX	Transmitter Models 8750W...R and 8750W...T + Flow Tube: ⓧ II 3 D Ex tc IIIC T80 °C...T130 °C Dc ** ⓧ II (3) G Ex tc [ic] IIIC T80 °C...T130 °C Dc **, *** Transmitter Model 8750W...W: ⓧ II 3 D Ex tc IIIC T80 °C Dc ** ⓧ II (3) G Ex tc [ic] IIIC T80 °C Dc **, ***
		NF IECEX	Transmitter Models 8750W...R and 8750W...T + Flow Tube: Ex tc IIIC T80 °C...T130 °C Dc ** Ex tc [ic] IIIC T80 °C...T130 °C Dc **, *** Transmitter Model 8750W...W: Ex tc IIIC T80 °C Dc ** Ex tc [ic] IIIC T80 °C Dc **, ***
			NOTE: * Model 8750W Transmitter DC Power Supply only ** Model 8750W Transmitter AC and DC Power Supply *** Intrinsically Safe Output (see IV) options F or P

Continued on next page

Rosemount 8750W Magnetic Flowmeter Platform IECEX & ATEX Approval Document

20 September 2020,
8750W-AP02, Rev AD

Nomenclature Magnetic Flow Meter System Model 8750W and electrical data (continued)

8750W ... R 1 A 2 ... F 005 ... Z1 ... M4 ... AX ... V1 ... R50
 I II III IV V VI VII VIII IX X XI XII

Designation	Explanation	Value	Explanation
IX	Transmitter Display	-- M4 M5	Without LOI and keypad LOI (+keypad for Transmitter model 8750W...W only) Display
X	Transmitter Discrete Input / Output	AX	Two Discrete Channels (DI/DO 1, DO 2)
XI	Specials Paint	Vx	Special Paint Systems *** NOTE: *** Subject to special conditions for safe use.
XII	Remote Cable	Rxx ****	Standard Temperature Component NOTE: **** Length = XX x 10ft., max 500 ft.



EU Declaration of Conformity No: RFD 1098 Rev. O

We,

**Emerson – Rosemount, Micro Motion Inc.
12001 Technology Drive
Eden Prairie, MN 55344
USA**

declare under our sole responsibility that the product(s),

Rosemount Model 8750W Magnetic Flowmeters

to which this declaration relates, is in conformity with the provisions of the European Union Legislation, including the latest amendments, as shown in the attached schedule.

Assumption of conformity is based on the application of harmonized or applicable technical standards and, when applicable or required, a European Union Legislation notified body certification, as shown in the attached schedule.

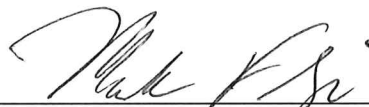

(signature)

22 June 2022

(date of issue)

Mark Fleigle

(name - printed)

Vice President - Technology and Product Development

(function name - printed)



Schedule
EU Declaration of Conformity RFD 1098 Rev. O

LVD Directive 2014/35/EU

All Models: EN 61010-1: 2010

EMC Directive 2014/30/EU

All Models: EN 61326-1: 2013

PED Directive 2014/68/EU

Model 8750W Magnetic Flowmeter Sensor with Option “PD”, in Line Sizes 1.5” – 24”

Equipment without the ‘PD’ option is NOT PED compliant and cannot be used in the EU without further assessment unless the installation is exempt under Article 1, paragraph 2 of the PED Directive 2014/68/EU.

QS Certificate of Assessment - 10000497900-PA-ACCREDIA-USA
Module H Conformity Assessment
ASME B31.3

Model 8750W in Line Sizes 0.5” – 1.0”

Sound Engineering Practice
ASME B31.3

RoHS Directive 2011/65/EU

All Models: EN 50581: 2012



Schedule
EU Declaration of Conformity RFD 1098 Rev. O

ATEX Directive 2014/34/EU

Model 8750W Magnetic Flowmeter Transmitter and Sensors

CERTIFICATE: DEKRA 15ATEX0003 X
Equipment Marking Summary:



- | | |
|--------|-------------------------------------|
| II 3 G | Ex nA [ic] IIC T4 Gc |
| II 3 G | Ex ec [ic] IIC T4 Gc |
| II 3 G | Ex nA ic IIC T5...T4 Gc |
| II 3 G | Ex ec ic IIC T5...T4 Gc |
| II 3 G | Ex nA ic [ic] IIC T4 Gc |
| II 3 G | Ex ec ic [ic] IIC T4 Gc |
| II 3 D | Ex tc IIIC T 80°C Dc |
| II 3 D | Ex tc IIIC T 80°C...T 130°C Dc |
| II 3 D | Ex tc [ic] IIIC T 80°C Dc |
| II 3 D | Ex tc [ic] IIIC T 80°C...T 130°C Dc |

EN IEC 60079-0: 2018
EN 60079-15: 2010

EN 60079-7: 2015 + A1 : 2018
EN 60079-31: 2014

EN 60079-11: 2012

PED Notified Body

DNV GL Business Assurance S.r.l. [Notified Body Number: 0496]
Via Energy Park 14
Vimercate, 20871 Italy

Authorized Representative in Europe:

Emerson S.R.L., company No. J12/88/2006, Emerson 4 street, Parcul Industrial
Tetarom II, Cluj-Napoca 400638, Romania

Regulatory Compliance Shared Services Department
Email: europeproductcompliance@emerson.com
Phone: +40 374 132 035

PAGE	TITLE
2	GAS ENVIRONMENT - CLASS I DIVISION 2 SENSORS AND ALLOWED INTEGRAL MOUNT CLASS I DIVISION 2 TRANSMITTERS
3	GAS ENVIRONMENT - CLASS I DIVISION 2 SENSORS AND ALLOWED REMOTE MOUNT CLASS I DIVISION 2 TRANSMITTERS
4	DUST ENVIRONMENT - CLASS II/III DIVISION 1 SENSORS AND ALLOWED INTEGRAL MOUNT CLASS II/III DIVISION 1 TRANSMITTERS
5	DUST ENVIRONMENT - CLASS II/III DIVISION 1 SENSORS AND ALLOWED REMOTE MOUNT CLASS II/III DIVISION 1 TRANSMITTERS
6	GAS AND DUST ENVIRONMENT - SENSOR TEMPERATURE CODE VS. PROCESS TEMPERATURE AND INGRESS PROTECTION RATINGS
7	GAS OR DUST ENVIRONMENT - COIL AND ELECTRODE CIRCUIT WIRING
8	GAS OR DUST ENVIRONMENT - OUTPUT WIRING - TRANSMITTER CLASS M
9	GAS AND DUST ENVIRONMENT - FIELDBUS AND PROFIBUS INTRINSICALLY SAFE CONCEPTS
10	GAS AND DUST ENVIRONMENT - FISCO CONCEPT
11	GAS AND DUST ENVIRONMENT - FM TO CSA COMPATIBILITY

⚠️ WARNING: EXPLOSION HAZARD - PRODUCT INSTALLATION SHALL COMPLY WITH INFORMATION AS STATED IN THIS DOCUMENT.

1. WIRING METHOD SUITABLE FOR APPROPRIATE CLASS DIVISION AND PROTECTION TYPE.
2. TRANSMITTER MUST NOT BE CONNECTED TO EQUIPMENT GENERATING MORE THAN 250V.
3. COMPONENTS REQUIRED TO HAVE HAZARDOUS LOCATION APPROVAL MUST BE APPROVED FOR THE GAS GROUP APPROPRIATE TO AREA CLASSIFICATION.
4. USA-INSTALLATION SHALL BE IN ACCORDANCE WITH THE NATIONAL ELECTRIC CODE (NEC), NFPA-70, AND ANSI/ISA-RP206.01. CANADA-INSTALLATION SHALL BE IN ACCORDANCE WITH THE CANADIAN ELECTRICAL CODE (CEC) PART I (C22.1).
5. THE TRANSMITTER IS NOT CAPABLE OF PASSING THE 500V ISOLATION TEST DUE TO INTEGRAL TRANSIENT PROTECTION. THIS MUST BE TAKEN INTO ACCOUNT UPON INSTALLATION.

6. FOR ALL INSTALLATIONS MAXIMUM TERMINAL TIGHTENING TORQUE IS 10.6 IN LBS.
7. - WARNING - EXPLOSION HAZARD - DO NOT DISCONNECT WHILE CIRCUIT IS LIVE UNLESS AREA IS KNOWN TO BE NON-HAZARDOUS.
 - AVERTISSEMENT - RISQUE D'EXPLOSION, NE PAS DEBRANCHER TANT QUE LE CIRCUIT EST SOUS TENSION, A MOINS QU'IL NE S'AGISSE D'UN EMPACEMENT NON DANGEREUX.
 - WARNING - AFTER DE-ENERGIZING, DELAY 10 MINUTES BEFORE OPENING.
 - AVERTISSEMENT - APRÈS MISE HORS TENSION, ATTENDRE 10 MINUTES AVANT L'OUVERTURE.
 - WARNING - POTENTIAL ELECTROSTATIC CHARGING HAZARD - SEE INSTRUCTIONS.
 - AVERTISSEMENT - DANGER POTENTIEL DE CHARGES ELECTROSTATIQUES - VOIR INSTRUCTIONS
8. NO REVISION TO THIS DRAWING WITHOUT PRIOR CSA APPROVAL.
9. THE INTRINSICALLY SAFE ANALOG AND DIGITAL OUTPUTS MUST USE TWISTED PAIR WITH AN INDIVIDUAL SHIELD FOR THE PAIR. IT IS ALSO RECOMMENDED TO USE SHIELDED TWISTED PAIR FOR THE PULSE OUTPUT.
10. SEAL APPROVED FOR USE IN APPROPRIATE ZONE AND GAS GROUP.
11. TRANSMITTER OUTPUTS ARE CONSIDERED INTRINSICALLY SAFE WHEN INSTALLED IN ACCORDANCE TO INTRINSICALLY SAFE CONCEPTS AND INSTALLATION REQUIREMENTS WITHIN THIS DOCUMENT.

NOTES:

CONFIDENTIAL AND PROPRIETARY INFORMATION IS CONTAINED HEREIN AND MUST BE HANDLED ACCORDINGLY.	SURFACE FINISH UNLESS OTHERWISE SPECIFIED		3RD ANGLE		SIZE	SCALE	REV
UNLESS OTHERWISE SPECIFIED DIMENSIONS IN INCHES (mm). REMOVE ALL BURRS AND SHARP EDGES.	X ± .1 [2.5] .XX ± .02 [0.5] .XXX ± .010 [0.25]	-DEC TOLERANCES- X ± .1 [2.5] .XX ± .02 [0.5] .XXX ± .010 [0.25]	FRACTIONS ± 1/32 ANGLES ± 2°	DO NOT SCALE PRINT	CAD MAINTAINED, (PROJ)	PRODUCT CODE	SHEET 1 OF 11
ROSEMOUNT							
TITLE INSTALLATION DRAWING 8750W, CSA CANADIAN AND USA CLASS DIVISION							
DR. J. LAGE 9/16/15 DRAWING NO. 8750W-1051				APPD. M. MAYER 9/16/15			

GAS ENVIRONMENT - CLASS I DIVISION 2 SENSORS AND ALLOWED INTEGRAL MOUNT CLASS I DIVISION 2 TRANSMITTERS

NON-INCENDIVE SENSOR INTEGRAL MOUNT CONFIGURATIONS

MODEL 8750WD INTEGRAL MOUNT CONFIGURATION
WITH SAFETY APPROVAL OPTION 'Z5' OR 'Z6'

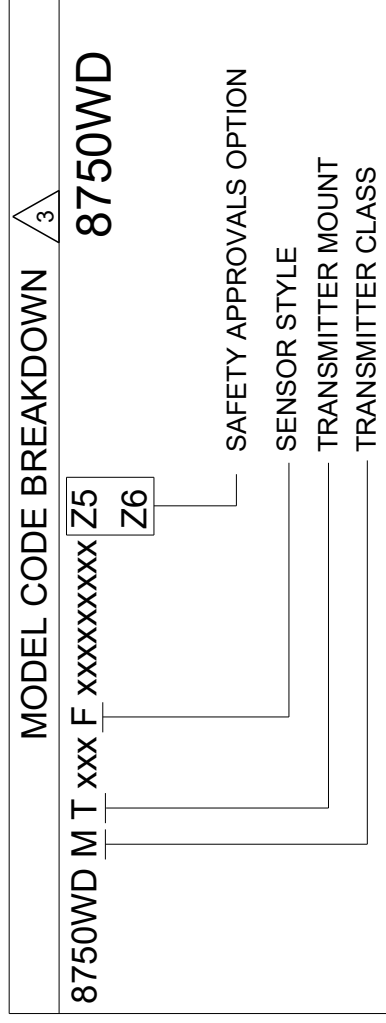

NON-INCENDIVE FOR CLASS I, DIV 2, GRPS ABCD: T4
WITH CARBON STEEL HOUSING (-29°C ≤ Ta ≤ 60°C)

ALLOWED INTEGRAL MOUNT TRANSMITTER CONFIGURATIONS

MODEL 8750WD INTEGRAL MOUNT CONFIGURATION
WITH SAFETY APPROVAL OPTION 'Z5' OR 'Z6'

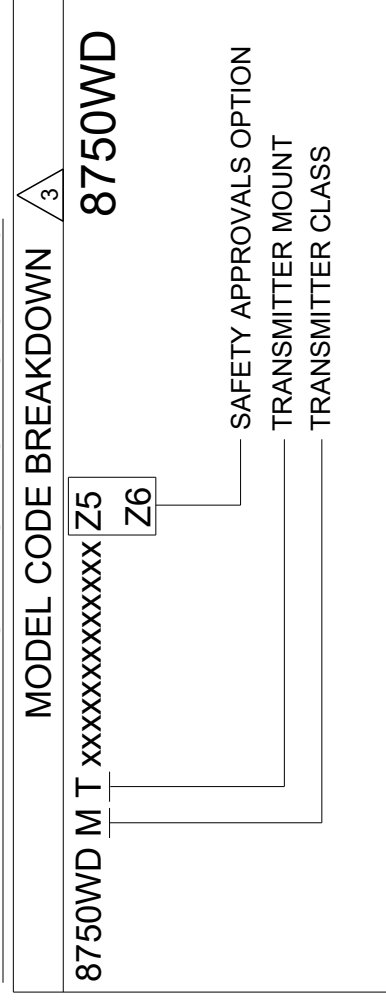

NON-INCENDIVE FOR CLASS I, DIV 2, GRPS ABCD: T4
AMBIENT TEMPERATURE (-29°C ≤ Ta ≤ 60°C)

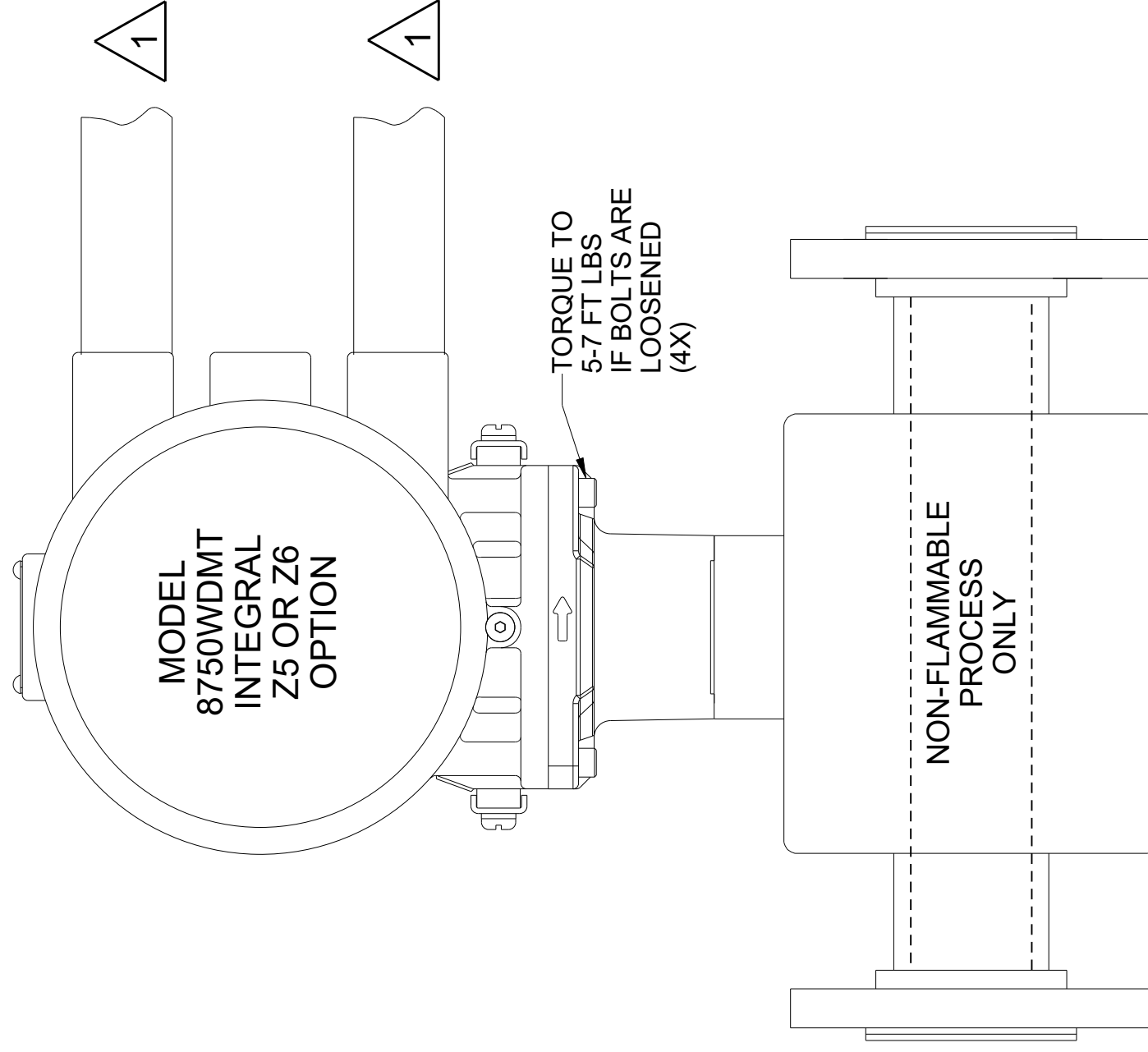

MODEL 8750WDMT INTEGRAL
Z5 OR Z6 OPTION

CONFIDENTIAL AND PROPRIETARY INFORMATION IS CONTAINED HEREIN AND MUST BE HANDLED ACCORDINGLY.	SURFACE FINISH UNLESS OTHERWISE SPECIFIED	125	3RD ANGLE		SIZE	C	SCALE	-	REV	AF
	DRAWING NO. 8750W-1051									
UNLESS OTHERWISE SPECIFIED DIMENSIONS IN INCHES (mm). REMOVE ALL BURRS AND SHARP EDGES.	EMERSON									
-DEC TOLERANCES-	ROSEMOUNT									
X ± .1 [2.5]	TITLE INSTALLATION DRAWING 8750W,									
.XX ± .02 [0.5]	CSA CANADIAN AND USA CLASS DIVISION									
.XXX ± .010 [0.25]	DR. J. LAGE 9/16/15 DRAWING NO. 8750W-1051									
FRACTIONS ± 1/32	APPD. M. MAYER 9/16/15 PRODUCT CODE									
ANGLES ± 2'	DO NOT SCALE PRINT CAD MAINTAINED (PROJ) SHEET 2 OF 11									

GAS ENVIRONMENT - CLASS I DIVISION 2 SENSORS AND ALLOWED REMOTE MOUNT CLASS I DIVISION 2 TRANSMITTERS

NON-INCENDIVE SENSOR REMOTE MOUNT CONFIGURATIONS

MODEL 8750WD REMOTE MOUNT SENSOR CONFIGURATION WITH SAFETY APPROVAL OPTION 'Z5' OR 'Z6'

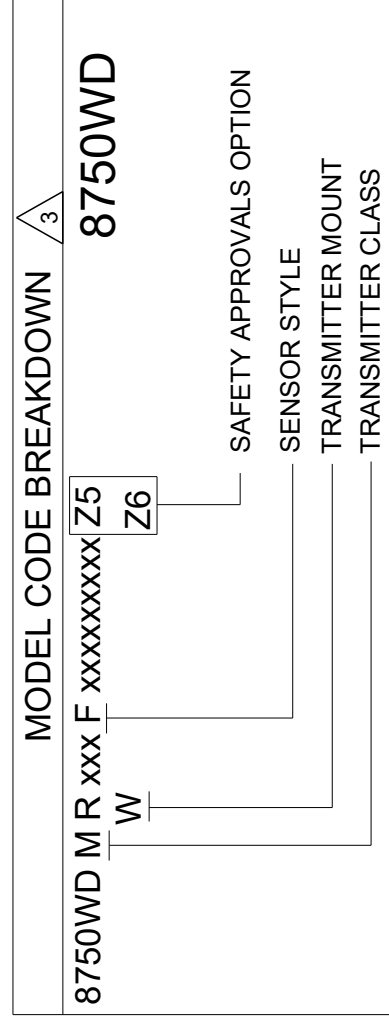

NON-INCENDIVE FOR CLASS I, DIV 2, GRPS ABCD: T4 WITH CARBON STEEL HOUSING (-29°C ≤ Ta ≤ 60°C)

ALLOWED REMOTE MOUNT TRANSMITTER CONFIGURATIONS

MODEL 8750WD REMOTE FIELD MOUNT CONFIGURATION WITH SAFETY APPROVAL OPTION 'Z5' OR 'Z6'

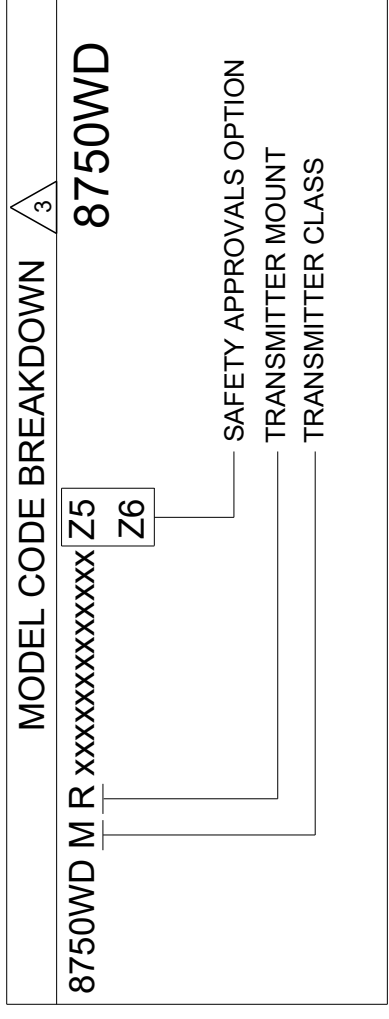

NON-INCENDIVE FOR CLASS I, DIV 2, GRPS ABCD: T4 AMBIENT TEMPERATURE (-29°C ≤ Ta ≤ 60°C)

MODEL 8750WD REMOTE WALLMOUNT CONFIGURATION WITH SAFETY APPROVAL OPTION 'ZC' OR 'Z6'

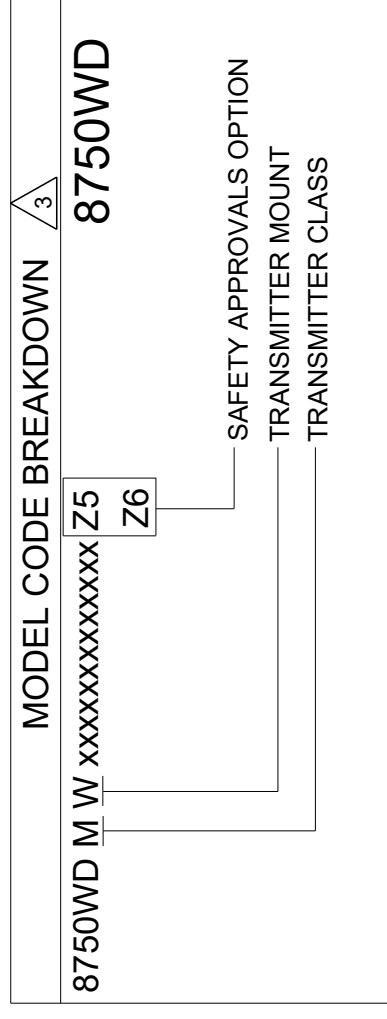

NON-INCENDIVE FOR CLASS I, DIV 2, GRPS ABCD: T4 AMBIENT TEMPERATURE (-40°C ≤ Ta ≤ 60°C)

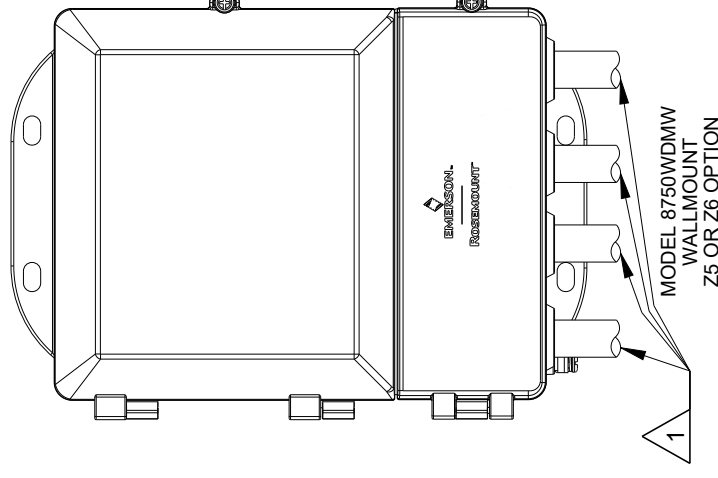
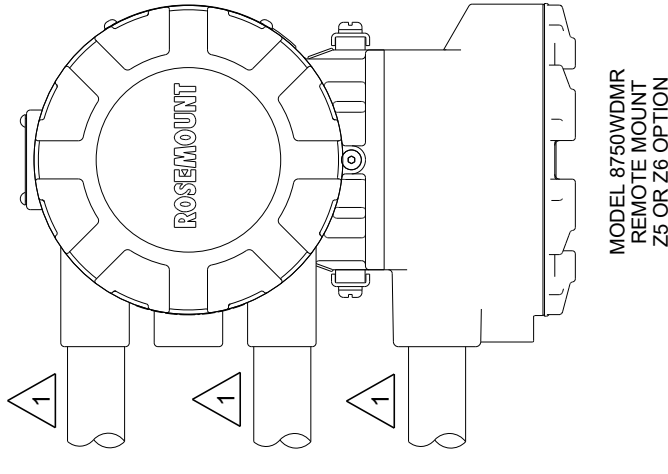
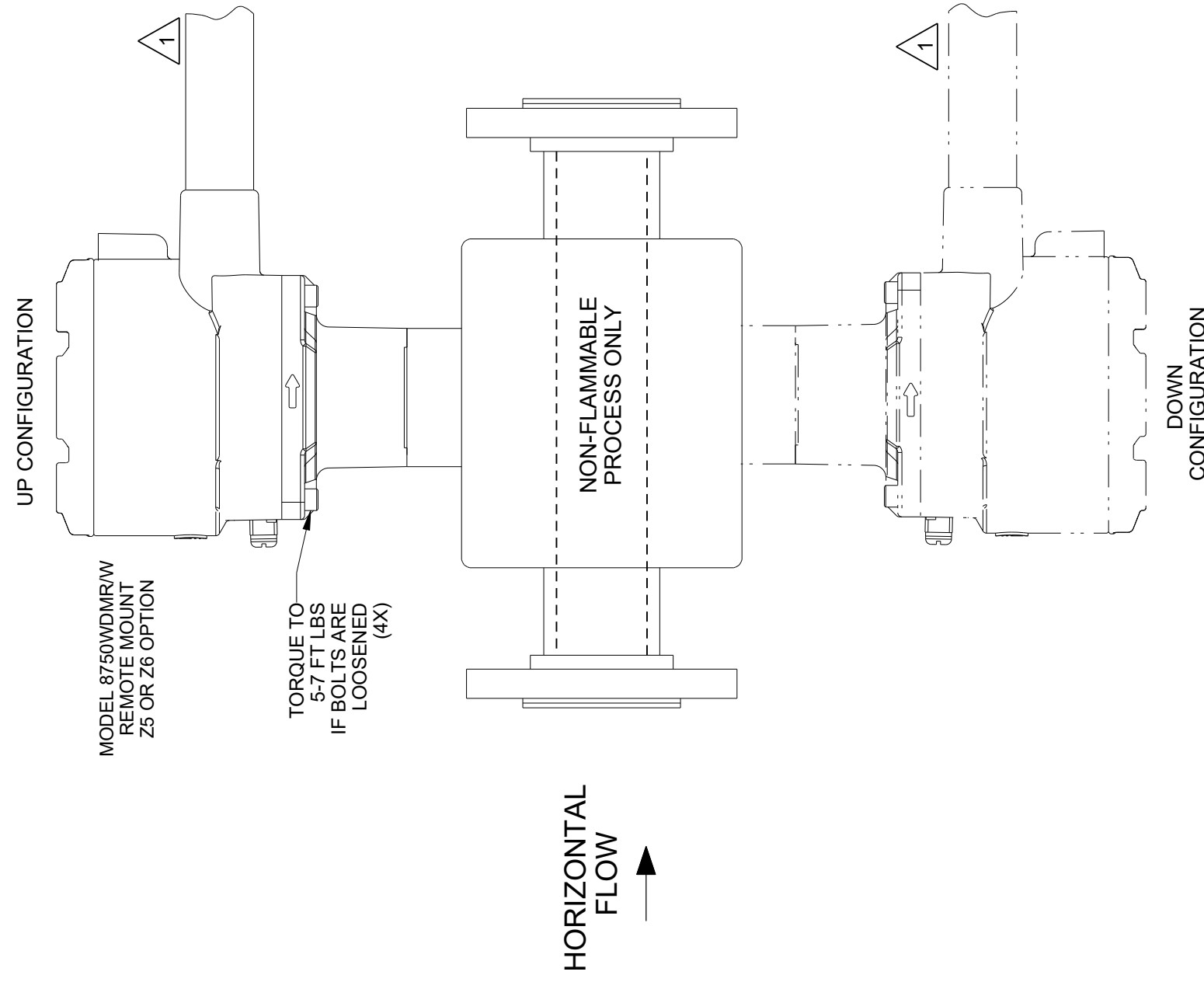

DRAWING NO. 8750W-1051

CONFIDENTIAL AND PROPRIETARY INFORMATION IS CONTAINED HEREIN AND MUST BE HANDLED ACCORDINGLY.	SURFACE FINISH UNLESS OTHERWISE SPECIFIED	¹²⁵	3RD ANGLE	SIZE C	SCALE -	REV AF
EMERSON ROSEMOUNT						
TITLE INSTALLATION DRAWING 8750W, CSA CANADIAN AND USA CLASS DIVISION						
DR. J. LAGE 9/16/15 DRAWING NO. 8750W-1051 APPD. M. MAYER 9/16/15						
DO NOT SCALE PRINT CAD MAINTAINED (PROJ) PRODUCT CODE SHEET 3 OF 11						

DUST ENVIRONMENT - CLASS II/III DIVISION 1 SENSORS AND ALLOWED INTEGRAL MOUNT CLASS II/III DIVISION 1 TRANSMITTERS

DUST-IGNITION PROOF SENSOR INTEGRAL MOUNT CONFIGURATIONS

MODEL 8750WD INTEGRAL MOUNT CONFIGURATION
WITH SAFETY APPROVAL OPTION 'Z5' OR 'Z6'

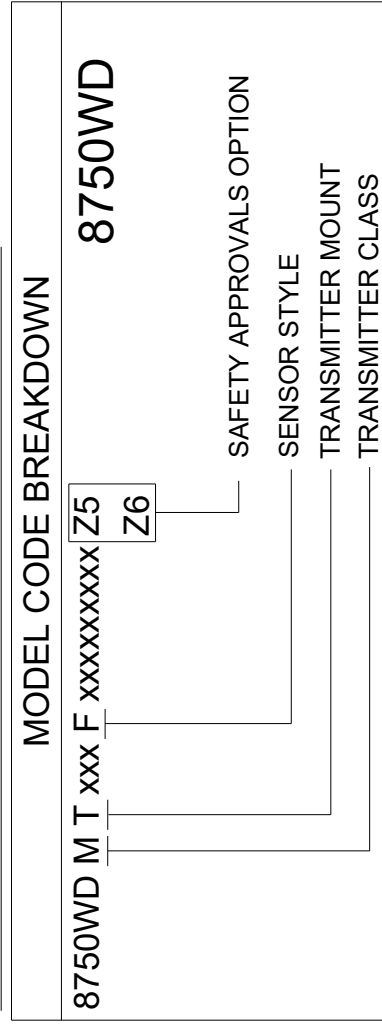

DUST-IGNITION PROOF FOR CLASS II/III DIV 1 GRPS EFG: T5
CARBON STEEL HOUSING (-29° ≤ Ta ≤ 60°C)

ALLOWED INTEGRAL MOUNT TRANSMITTER CONFIGURATIONS

MODEL 8750WD INTEGRAL MOUNT CONFIGURATION
WITH SAFETY APPROVAL OPTION 'Z5' OR 'Z6'

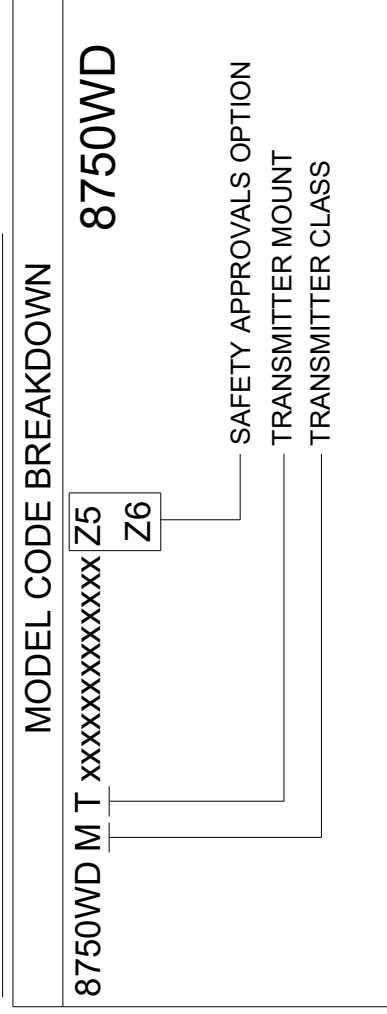

DUST-IGNITION PROOF FOR CLASS II/III DIV 1 GRPS EFG: T5
AMBIENT TEMPERATURE (-29° ≤ Ta ≤ 60°C)

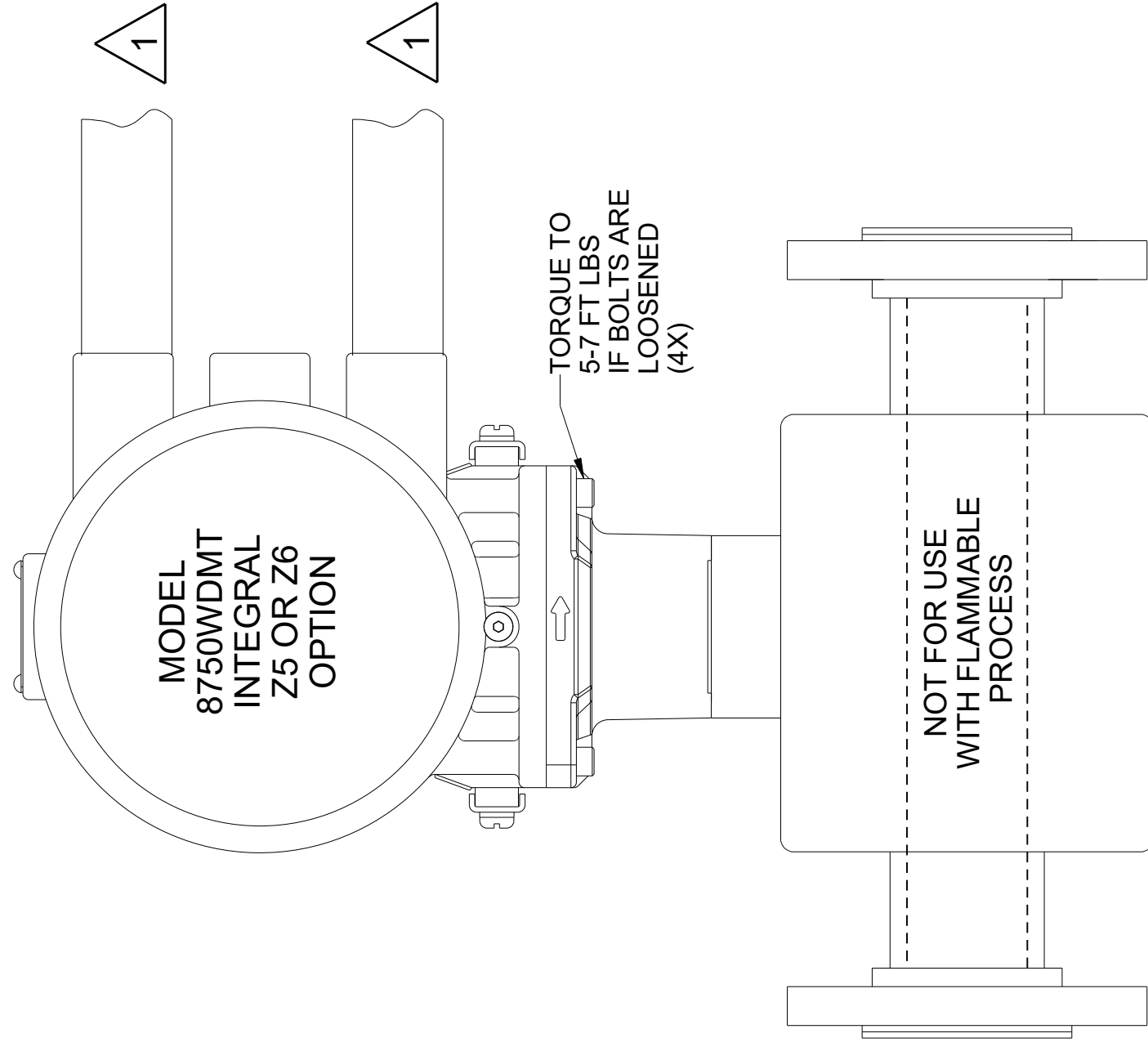

MODEL 8750WDMT INTEGRAL
Z5 OR Z6 OPTION

CONFIDENTIAL AND PROPRIETARY INFORMATION IS CONTAINED HEREIN AND MUST BE HANDLED ACCORDINGLY.	SURFACE FINISH UNLESS OTHERWISE SPECIFIED	125	3RD ANGLE		SIZE	C	SCALE	-	REV	AF
	DRAWING NO. 8750W-1051									
EMERSON										
ROSEMOUNT										
TITLE INSTALLATION DRAWING 8750W, CSA CANADIAN AND USA CLASS DIVISION										
DR.	J. LAGE	9/16/15	DRAWING NO.		8750W-1051					
APPD.	M. MAYER	9/16/15	PRODUCT CODE		DO NOT SCALE PRINT CAD MAINTAINED (PROJ)					

UNLESS OTHERWISE SPECIFIED DIMENSIONS IN INCHES (mm). REMOVE ALL BURRS AND SHARP EDGES.

-DEC TOLERANCES-	
X ± .1	[2.5]
.XX ± .02	[0.5]
.XXX ± .010	[0.25]
FRACTIONS ± 1/32	ANGLES ± 2°

DUST ENVIRONMENT - CLASS II/III DIVISION 1 SENSORS AND ALLOWED REMOTE MOUNT CLASS II/III DIVISION 1 TRANSMITTERS

DUST-IGNITION PROOF SENSOR REMOTE MOUNT CONFIGURATIONS

MODEL 8750WD REMOTE MOUNT SENSOR CONFIGURATION
WITH SAFETY APPROVAL OPTION 'Z5' OR 'Z6'

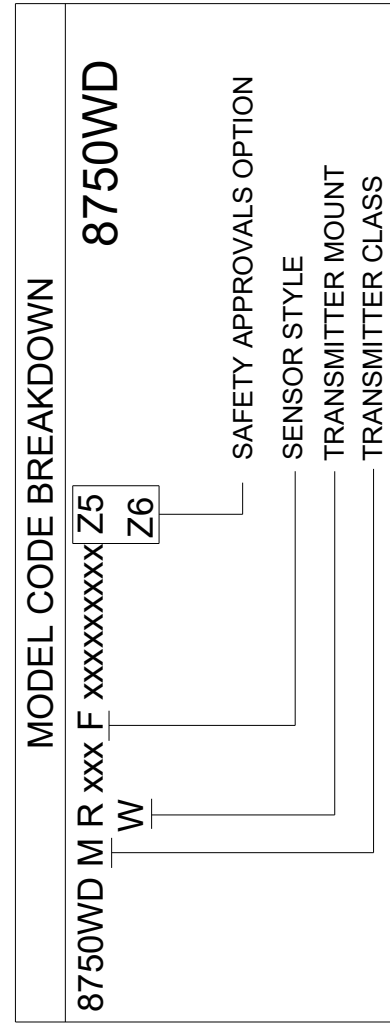

DUST-IGNITION PROOF FOR CLASS II/III DIV 1 GRPS EFG: T5
WITH CARBON STEEL HOUSING ($-29^{\circ}\text{C} \leq \text{Ta} \leq 60^{\circ}\text{C}$)

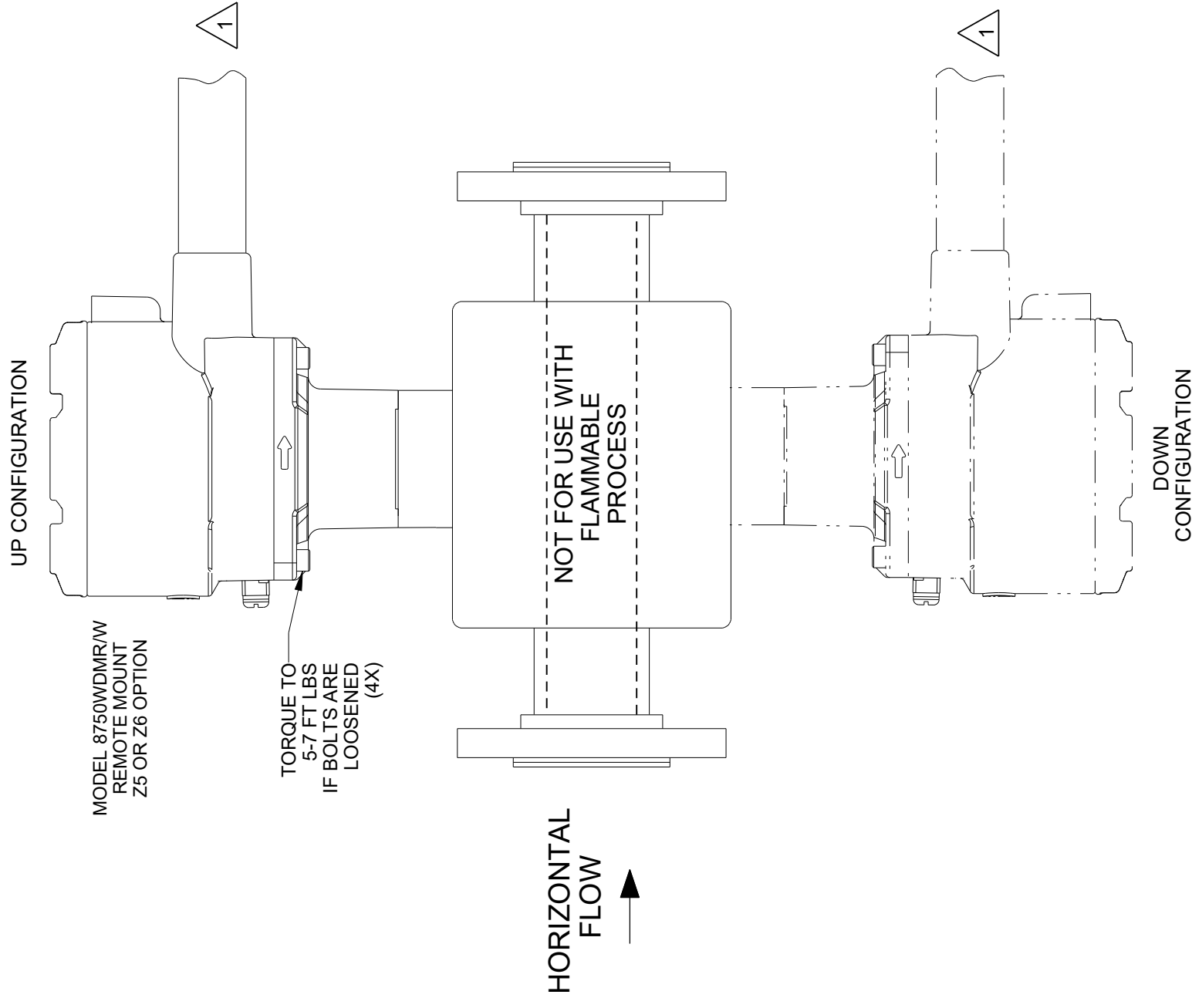

ALLOWED REMOTE MOUNT TRANSMITTER CONFIGURATIONS

MODEL 8750WD REMOTE FIELD MOUNT CONFIGURATION
WITH SAFETY APPROVAL OPTION 'Z5' OR 'Z6'

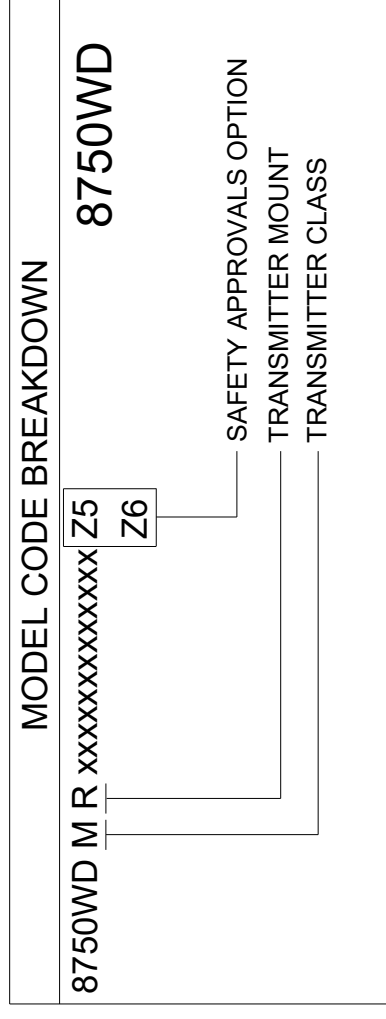

DUST-IGNITION PROOF FOR CLASS II/III DIV 1 GRPS EFG: T5
AMBIENT TEMPERATURE ($-29^{\circ}\text{C} \leq \text{Ta} \leq 60^{\circ}\text{C}$)

MODEL 8750WD REMOTE WALLMOUNT CONFIGURATION
WITH SAFETY APPROVAL OPTION 'Z5' OR 'Z6'

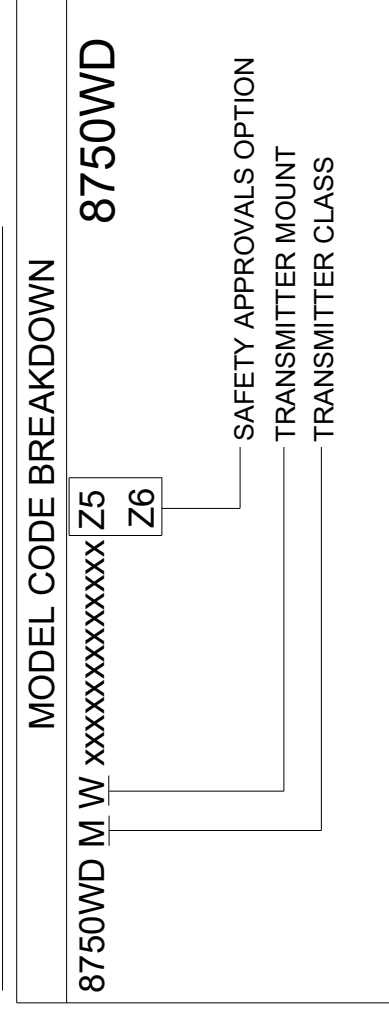

DUST-IGNITION PROOF FOR CLASS II/III DIV 1 GRPS EFG: T5
AMBIENT TEMPERATURE ($-40^{\circ}\text{C} \leq \text{Ta} \leq 60^{\circ}\text{C}$)

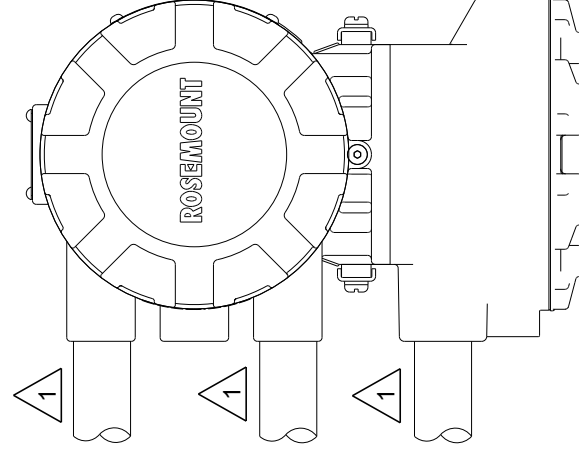

MODEL 8750WDMR
REMOTE MOUNT
Z5 OR Z6 OPTION

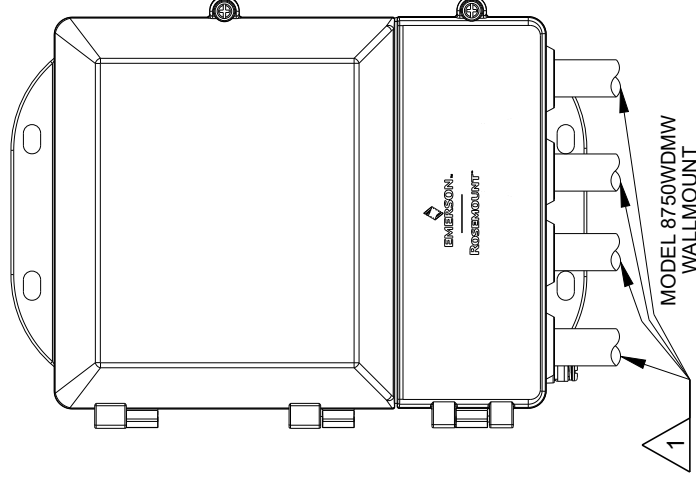

MODEL 8750WDMW
WALLMOUNT
Z5 OR Z6 OPTION

8750W-1051

DRAWING NO.

SURFACE FINISH UNLESS OTHERWISE SPECIFIED ∇ 125

CONFIDENTIAL AND PROPRIETARY INFORMATION IS CONTAINED HEREIN AND MUST BE HANDLED ACCORDINGLY.

UNLESS OTHERWISE SPECIFIED DIMENSIONS IN INCHES (mm). REMOVE ALL BURRS AND SHARP EDGES.

-DEC TOLERANCES-
X ± .1 [2.5]
.XX ± .02 [0.5]
.XXX ± .010 [0.25]
FRACTIONS ± 1/32 ANGLES ± 2°

DO NOT SCALE PRINT CAD MAINTAINED (PROJ)

DO NOT SCALE PRINT CAD MAINTAINED (PROJ)

DO NOT SCALE PRINT CAD MAINTAINED (PROJ)

DO NOT SCALE PRINT CAD MAINTAINED (PROJ)



ROSEMOUNT

TITLE
INSTALLATION DRAWING 8750W,
CSA CANADIAN AND USA CLASS DIVISION

DR. J. LAGE 9/16/15 DRAWING NO. 8750W-1051
APPD. M. MAYER 9/16/15

DO NOT SCALE PRINT CAD MAINTAINED (PROJ) PRODUCT CODE SHEET 5 OF 11

GAS AND DUST ENVIRONMENT - SENSOR TEMPERATURE CODE VS. PROCESS TEMPERATURE AND INGRESS PROTECTION RATINGS

TABLE 1 - 8750W: NON-INCENDIVE SAFETY APPROVAL OPTION 'Z5' OR 'Z6' ALLOWED TRANSMITTER MOUNTING AND TEMPERATURE CODE VS. PROCESS TEMPERATURE

LINE SIZE	MAXIMUM PROCESS TEMPERATURE (°C)	T CLASSIFICATION CODE	MOUNTING CONFIGURATION
ALL	60	T4	SENSOR WITH INTEGRAL MOUNT TRANSMITTER
ALL	90	T4	SENSOR WITH INTEGRAL MOUNT TRANSMITTER
ALL	60	T4	REMOTE SENSOR WITH REMOTE JUNCTION BOX (RJB)
ALL	90	T4	REMOTE SENSOR WITH REMOTE JUNCTION BOX (RJB)
ALL	120	T4	REMOTE SENSOR WITH REMOTE JUNCTION BOX (RJB)
ALL	NOT APPLICABLE	T4	REMOTE FIELD MOUNT TRANSMITTER
ALL	NOT APPLICABLE	T4	REMOTE WALLMOUNT TRANSMITTER

TABLE 2 - 8750W: DUST-IGNITION PROOF SAFETY APPROVAL OPTION 'Z5' OR 'Z6' ALLOWED TRANSMITTER MOUNTING AND TEMPERATURE CODE VS. PROCESS TEMPERATURE

LINE SIZE	MAXIMUM PROCESS TEMPERATURE (°C)	DUST TEMPERATURE CODE	MOUNTING CONFIGURATION
ALL	60	T5	SENSOR WITH INTEGRAL MOUNT TRANSMITTER
ALL	90	T5	SENSOR WITH INTEGRAL MOUNT TRANSMITTER
ALL	60	T5	REMOTE SENSOR WITH REMOTE JUNCTION BOX (RJB)
ALL	90	T5	REMOTE SENSOR WITH REMOTE JUNCTION BOX (RJB)
ALL	120	T4	REMOTE SENSOR WITH REMOTE JUNCTION BOX (RJB)
ALL	NOT APPLICABLE	T5	REMOTE FIELD MOUNT TRANSMITTER
ALL	NOT APPLICABLE	T5	REMOTE WALLMOUNT TRANSMITTER

TABLE 3 - 8750W: INGRESS PROTECTION AND CORROSION PROTECTION RATINGS SAFETY APPROVAL OPTION 'Z5' OR 'Z6' ALLOWED TRANSMITTER MOUNTING AND PROTECTION RATINGS

LINE SIZE	IP RATING	NEMA RATING	MOUNTING CONFIGURATION
ALL	IP66	TYPE 4X	SENSOR WITH INTEGRAL MOUNT TRANSMITTER
ALL	IP66	TYPE 4X	REMOTE FIELD MOUNT TRANSMITTER
ALL	IP66	TYPE 4X	REMOTE WALLMOUNT TRANSMITTER
ALL	IP66, IP68* or IP69K	TYPE 4X	REMOTE SENSOR WITH REMOTE JUNCTION BOX (RJB)

* IP x8 submergence depth is 10 meters (30 feet) for 48 hours duration

CONFIDENTIAL AND PROPRIETARY INFORMATION IS CONTAINED HEREIN AND MUST BE HANDLED ACCORDINGLY.

UNLESS OTHERWISE SPECIFIED DIMENSIONS IN INCHES (mm). REMOVE ALL BURRS AND SHARP EDGES.

-DEC TOLERANCES-
X ± .1 [2.5]
XX ± .02 [0.5]
XXX ± .010 [0.25]
FRACTIONS ANGLES
± 1/32 ± 2°



TITLE
INSTALLATION DRAWING 8750W,
CSA CANADIAN AND USA CLASS DIVISION

DR. J. LAGE 9/16/15 DRAWING NO. 8750W-1051
APPD. M. MAYER 9/16/15

ROSEMOUNT

SURFACE FINISH UNLESS OTHERWISE SPECIFIED 125
3RD ANGLE
SIZE C
SCALE -
REV AF
DRAWING NO. 8750W-1051

GAS OR DUST ENVIRONMENT - COIL AND ELECTRODE CIRCUIT WIRING

MODEL 8750WD WITH NON-INTRINSICALLY SAFE COIL AND ELECTRODE CIRCUITS FOR USE WITH

SAFETY APPROVAL OPTION Z5 OR Z6
SEE INSTALLATION WIRING DRAWING 08732-1504 FOR CABLING DETAILS.
(FOR PROCESS TEMPERATURE LIMITS SEE TABLE 1 OR TABLE 2)

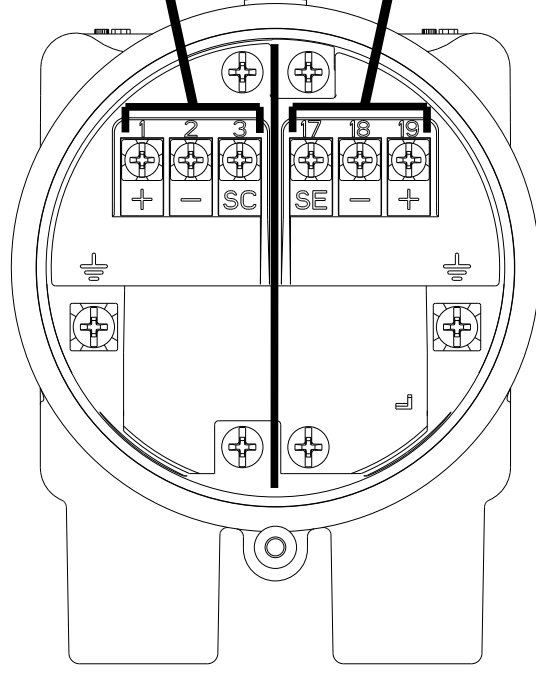

NON-INTRINSICALLY SAFE COIL CIRCUIT WIRING
INSTALL AS NON-INCENDIVE OR
CLASS II/III DUST-IGNITION PROOF

NON-INTRINSICALLY SAFE ELECTRODE CIRCUIT WIRING
INSTALL AS NON-INCENDIVE OR
CLASS II/III DUST-IGNITION PROOF

8750WDMR TRANSMITTER
REMOTE JUNCTION BOX

TERMINAL	LABEL
ELECTRODE CIRCUIT	
19	ELECTRODE +
18	ELECTRODE -
17	ELECTRODE REFERENCE (SE)
COIL CIRCUIT	
1	COIL +
2	COIL -
3	COIL SHIELD (SC)

MODEL 8750WDM WITH NON-INTRINSICALLY SAFE COIL AND ELECTRODE CIRCUITS FOR USE WITH

WITH SAFETY APPROVAL OPTION Z5 OR Z6
SEE INSTALLATION WIRING DRAWING 08712-1504 FOR CABLING DETAILS.
(FOR PROCESS TEMPERATURE LIMITS SEE TABLE 1 OR TABLE 2)

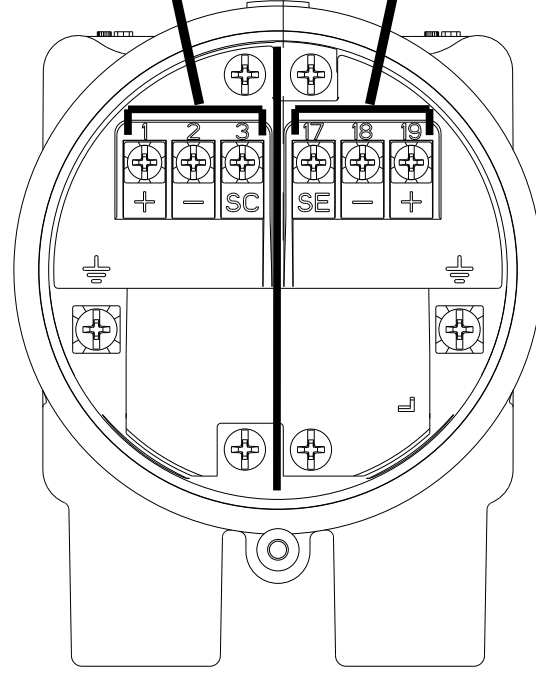

NON-INTRINSICALLY SAFE COIL CIRCUIT WIRING
INSTALL AS NON-INCENDIVE OR
CLASS II/III DUST-IGNITION PROOF

NON-INTRINSICALLY SAFE ELECTRODE CIRCUIT WIRING
INSTALL AS NON-INCENDIVE OR
CLASS II/III DUST-IGNITION PROOF

8750WDMW TRANSMITTER
(LOWER COVER AND SAFETY COVER ARE NOT SHOWN)

TERMINAL	LABEL
ELECTRODE CIRCUIT	
19	ELECTRODE +
18	ELECTRODE -
17	ELECTRODE REFERENCE (SE)
COIL CIRCUIT	
1	COIL +
2	COIL -
3	COIL SHIELD (SC)

DRAWING NO. 8750W-1051

CONFIDENTIAL AND PROPRIETARY
INFORMATION IS CONTAINED HEREIN
AND MUST BE HANDLED ACCORDINGLY.

UNLESS OTHERWISE SPECIFIED
DIMENSIONS IN INCHES (mm). REMOVE
ALL BURRS AND SHARP EDGES.

-DEC TOLERANCES-
X ± .1 [2.5]
.XX ± .02 [0.5]
.XXX ± .010 [0.25]
FRACTIONS ANGLES
± 1/32 ± 2°

SURFACE FINISH UNLESS
OTHERWISE SPECIFIED

125° 3RD ANGLE

SIZE C

SCALE -

REV AF



ROSEMOUNT

TITLE
**INSTALLATION DRAWING 8750W,
CSA CANADIAN AND USA CLASS DIVISION**

DR. J. LAGE 9/16/15 DRAWING NO. 8750W-1051
APPD. M. MAYER 9/16/15

DO NOT SCALE PRINT CAD MAINTAINED. (PROJ) PRODUCT CODE SHEET 7 OF 11

GAS OR DUST ENVIRONMENT - OUTPUT WIRING - TRANSMITTER CLASS M

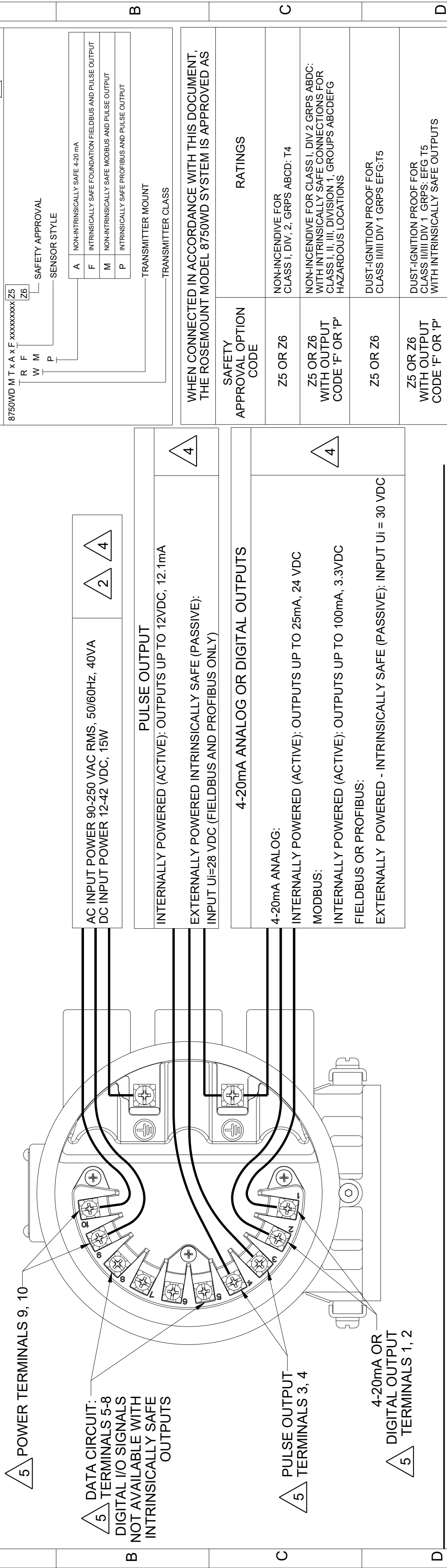

AC INPUT POWER 90-250 VAC RMS, 50/60Hz, 40VA
DC INPUT POWER 12-42 VDC, 15W

PULSE OUTPUT
INTERNALLY POWERED (ACTIVE): OUTPUTS UP TO 12VDC, 12.1mA
EXTERNALLY POWERED INTRINSICALLY SAFE (PASSIVE):
INPUT U_i=28 VDC (FIELDBUS AND PROFIBUS ONLY)

4-20mA ANALOG OR DIGITAL OUTPUTS
4-20mA ANALOG:
INTERNALLY POWERED (ACTIVE): OUTPUTS UP TO 25mA, 24 VDC
MODBUS:
INTERNALLY POWERED (ACTIVE): OUTPUTS UP TO 100mA, 3.3VDC
FIELDBUS OR PROFIBUS:
EXTERNALLY POWERED - INTRINSICALLY SAFE (PASSIVE): INPUT U_i = 30 VDC

8750WD MODEL CODE BREAKDOWN

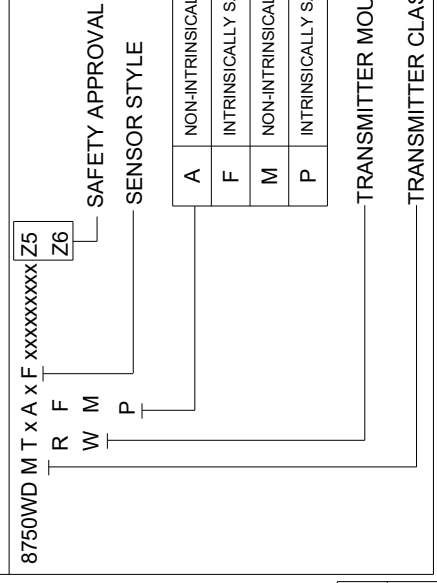

WHEN CONNECTED IN ACCORDANCE WITH THIS DOCUMENT, THE ROSEMOUNT MODEL 8750WD SYSTEM IS APPROVED AS

SAFETY APPROVAL OPTION CODE	RATINGS
Z5 OR Z6	NON-INCENDIVE FOR CLASS I, DIV. 2, GRPS ABCD: T4
Z5 OR Z6 WITH OUTPUT CODE 'F' OR 'P'	NON-INCENDIVE FOR CLASS I, DIV. 2 GRPS ABCD: WITH INTRINSICALLY SAFE CONNECTIONS FOR CLASS I, II, III, DIVISION 1, GROUPS ABCDEFG HAZARDOUS LOCATIONS
Z5 OR Z6	DUST-IGNITION PROOF FOR CLASS III/III DIV 1 GRPS EFG:T5
Z5 OR Z6 WITH OUTPUT CODE 'F' OR 'P'	DUST-IGNITION PROOF FOR CLASS III/III DIV 1 GRPS EFG:T5 WITH INTRINSICALLY SAFE OUTPUTS

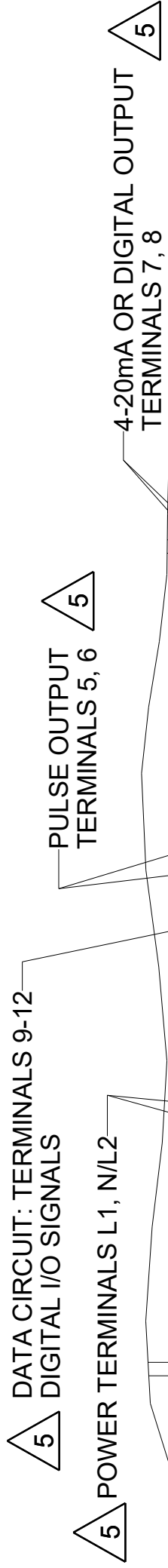

4-20mA ANALOG OR DIGITAL OUTPUTS

4-20mA ANALOG:
INTERNALLY POWERED (ACTIVE): OUTPUTS UP TO 25mA, 24 VDC
MODBUS:
INTERNALLY POWERED (ACTIVE): OUTPUTS UP TO 100mA, 3.3VDC
FIELDBUS OR PROFIBUS:
EXTERNALLY POWERED - INTRINSICALLY SAFE (PASSIVE): INPUT U_i = 30VDC

PULSE OUTPUT
INTERNALLY POWERED (ACTIVE): OUTPUTS UP TO 12VDC, 12.1mA
EXTERNALLY POWERED - INTRINSICALLY SAFE (PASSIVE)
INPUT U_i = 28VDC (FIELDBUS AND PROFIBUS ONLY)

AC INPUT POWER 90-250 VAC RMS, 50/60Hz, 40VA
DC INPUT POWER 12-42 VDC, 15W

8750W-1051

CONFIDENTIAL AND PROPRIETARY INFORMATION IS CONTAINED HEREIN AND MUST BE HANDLED ACCORDINGLY.	SURFACE FINISH UNLESS OTHERWISE SPECIFIED	125	3RD ANGLE	SIZE	C	SCALE	-	REV	AF
UNLESS OTHERWISE SPECIFIED DIMENSIONS IN INCHES (mm). REMOVE ALL BURRS AND SHARP EDGES.	<p style="text-align: center;">EMERSON ROSEMOUNT</p> <p style="text-align: center;">TITLE INSTALLATION DRAWING 8750W, CSA CANADIAN AND USA CLASS DIVISION</p>								
-DEC TOLERANCES-									
X ± .1 [2.5]									
.XX ± .02 [0.5]									
.XXX ± .010 [0.25]									
FRACTIONS ± 1/32	ANGLES ± 2°								
DO NOT SCALE PRINT	CAD MAINTAINED, (PROE)	PRODUCT CODE	DOC TYPE	SHEET 8	OF 11				

GAS AND DUST ENVIRONMENT - INTRINSICALLY SAFE ENTITY CONCEPTS

8750WDMT/R ENTITY CONCEPT FOR INTRINSICALLY SAFE OUTPUTS

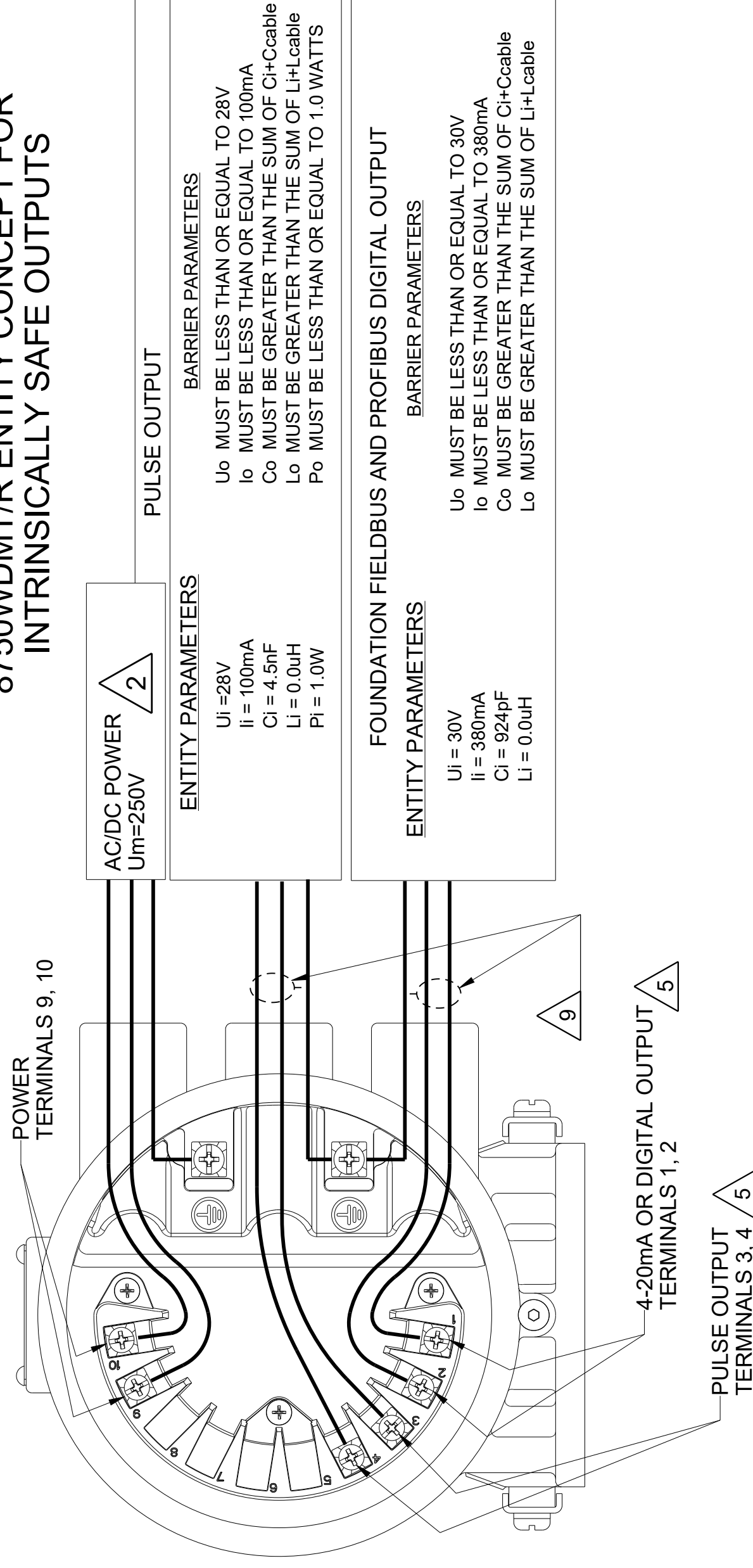

DEFINITIONS:

- Ui = MAXIMUM INPUT VOLTAGE
- Ii = MAXIMUM INPUT CURRENT
- Ci = MAXIMUM INTERNAL CAPACITANCE
- Li = MAXIMUM INTERNAL INDUCTANCE
- Pi = MAXIMUM INPUT POWER
- Uo = OPEN CIRCUIT VOLTAGE OF THE BARRIER
- Io = SHORT CIRCUIT CURRENT OF THE BARRIER
- Co = MAXIMUM ALLOWED CAPACITANCE
- Lo = MAXIMUM ALLOWED INDUCTANCE
- Po = MAXIMUM OUTPUT POWER

THE ENTITY CONCEPT ALLOWS INTERCONNECTION OF ASSOCIATED APPARATUS AND INTRINSICALLY SAFE APPARATUS WHEN THE FOLLOWING IS TRUE:
 $U_o \leq U_i, I_o \leq I_i, P_o \leq P_i, C_o \geq C_i + C_{cable}, L_o \geq L_i + L_{cable}$

ASSOCIATED APPARATUS MUST BE CERTIFIED, AND FOLLOW MANUFACTURER'S INSTALLATION DRAWINGS. TO MAINTAIN THE INTRINSICALLY SAFE OUTPUT THE TRANSMITTER MUST BE CONNECTED TO A CERTIFIED BARRIER THAT SATISFIES THE FOLLOWING CONDITIONS.

APPROVED WITH INTRINSICALLY SAFE CONNECTIONS FOR CLASS I, DIVISION 1, GROUPS ABCD; CLASS II AND III, DIVISION 1, GROUPS EFG.

8750WDMW ENTITY CONCEPT FOR INTRINSICALLY SAFE OUTPUTS

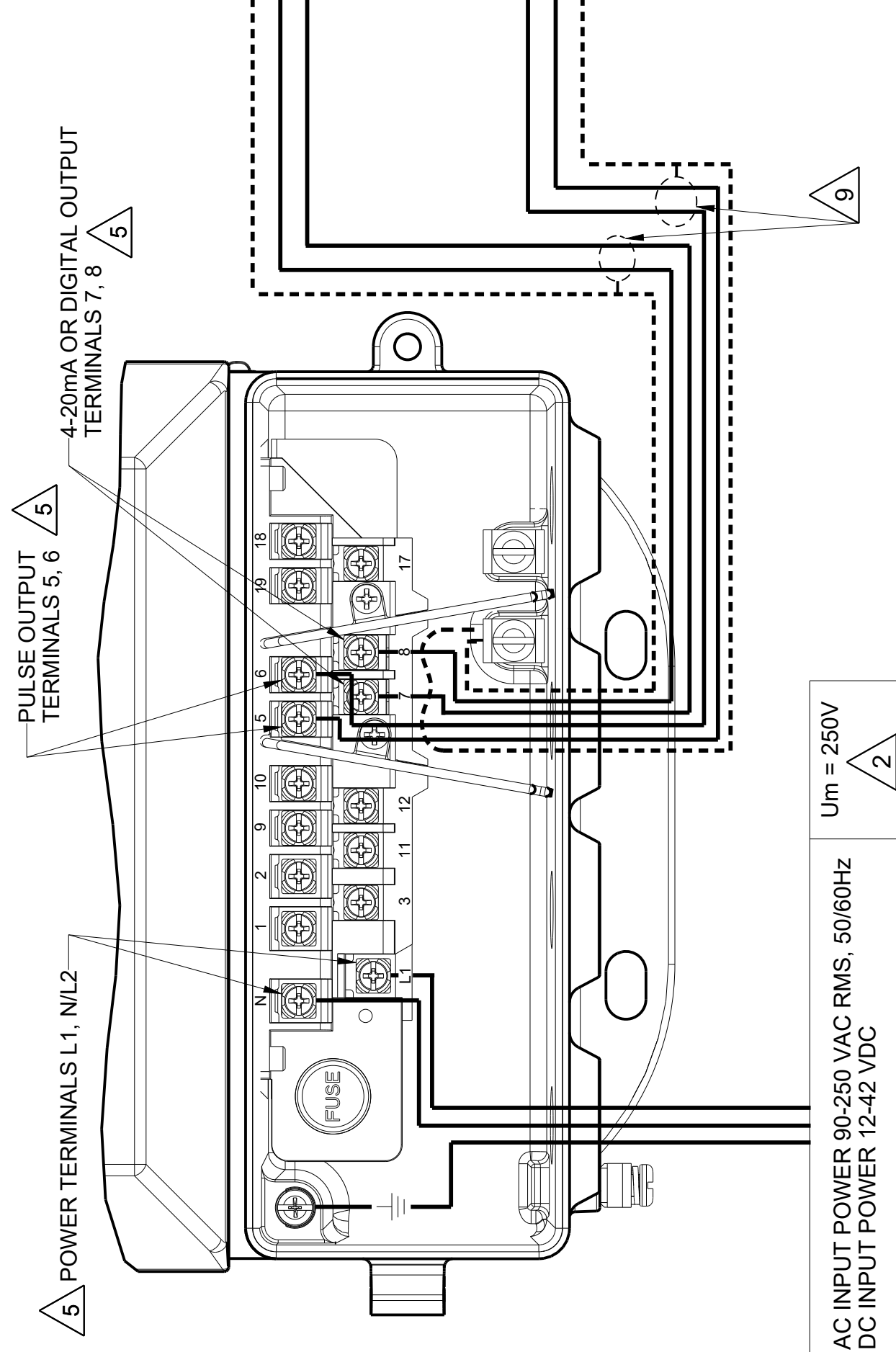

DRAWING NO. 8750W-1051

CONFIDENTIAL AND PROPRIETARY INFORMATION IS CONTAINED HEREIN AND MUST BE HANDLED ACCORDINGLY.	SURFACE FINISH UNLESS OTHERWISE SPECIFIED	125	3RD ANGLE	SIZE	SCALE	REV
		✓	☉	C	-	AF
EMERSON ROSEMOUNT						
TITLE INSTALLATION DRAWING 8750W,						
CSA CANADIAN AND USA CLASS DIVISION						
DR.	J. LAGE	9/16/15	DRAWING NO.	8750W-1051		
APPD.	M. MAYER	9/16/15	PRODUCT CODE	SHEET9 OF 11		
DO NOT SCALE PRINT CAD MAINTAINED. (PROJ)						

GAS AND DUST ENVIRONMENT - FISCO CONCEPT

FISCO CONCEPT

THE FISCO CONCEPT ALLOWS INTERCONNECTION OF INTRINSICALLY SAFE APPARATUS TO ASSOCIATED APPARATUS NOT SPECIALLY EXAMINED IN SUCH COMBINATION. THE CRITERIA FOR INTERCONNECTION IS THAT THE VOLTAGE (V_{max}), THE CURRENT (I_{max}), AND THE POWER (P_{max}) WHICH AN INTRINSICALLY SAFE APPARATUS CAN RECEIVE AND REMAIN INTRINSICALLY SAFE CONSIDERING FAULTS, MUST BE EQUAL OR GREATER THAN VOLTAGE (V_{oc}), AND CURRENT (I_{sc}) WHICH CAN BE DELIVERED BY THE ASSOCIATED APPARATUS, CONSIDERING FAULTS AND APPLICABLE FACTORS. IN ADDITION, THE MAXIMUM UNPROTECTED CAPACITANCE (C_i) AND THE INDUCTANCE (L_i) OF EACH APPARATUS (OTHER THAN THE TERMINATION) CONNECTED TO THE FIELDBUS MUST BE LESS THAN OR EQUAL TO 5 nF AND 10 uH RESPECTIVELY.

IN EACH SEGMENT ONLY ONE ACTIVE DEVICE, NORMALLY THE ASSOCIATED APPARATUS, IS ALLOWED TO PROVIDE THE NECESSARY ENERGY FOR THE FIELDBUS SYSTEM. THE VOLTAGE (V_{oc}) OF THE ASSOCIATED APPARATUS IS LIMITED TO A RANGE OF 14 TO 17.5 VDC. ALL OTHER EQUIPMENT CONNECTED TO THE BUS CABLE HAS TO BE PASSIVE, MEANING THAT THEY ARE NOT ALLOWED TO PROVIDE ENERGY TO THE SYSTEM, EXCEPT A LEAKAGE CURRENT OF 50 μA FOR EACH CONNECTED DEVICE. SEPARATELY POWERED EQUIPMENT NEEDS GALVANIC ISOLATION TO ASSURE THAT THE INTRINSICALLY SAFE FIELDBUS CIRCUIT REMAINS PASSIVE.

THE CABLE USED TO INTERCONNECT DEVICES NEEDS TO HAVE THE PARAMETERS IN THE FOLLOWING RANGE:

Loop Resistance R_c :	15.....150 Ohm/km
Inductance per unit length L_c :	0.4.....1 mH/km
Capacitance per unit length C_c :	45.....200 nF
Length of trunk cable:	less than or equal to 1000m
Length of spur cable:	less than or equal to 60m

AT EACH END OF THE TRUNK CABLE AN APPROVED INFALLIBLE LINE TERMINATION WITH THE FOLLOWING PARAMETERS IS SUITABLE:

$$R = 90.....102 \text{ Ohm} \quad C = 0.....2.2 \text{ } \mu\text{f}$$

ONE OF THE ALLOWED TERMINATIONS MIGHT ALREADY BE INTEGRATED IN THE ASSOCIATED APPARATUS. THE NUMBER OF PASSIVE APPARATUS CONNECTED TO THE BUS SEGMENT IS NOT LIMITED TO I.S. REASONS. IF THE ABOVE RULES ARE RESPECTED, UP TO A TOTAL LENGTH OF 1000 m (SUM OF TRUNK AND ALL SPUR CABLES) OF CABLE IS PERMITTED. THE INDUCTANCE AND THE CAPACITANCE OF THE CABLE WILL NOT IMPAIR THE INTRINSIC SAFETY OF THE INSTALLATION.

ENTITY PARAMETER

U_i	= 30V
I_i	= 380 mA
C_i	= 924 pF
L_i	= 0.0 uH
P_i	= 5.32 W

BARRIER PARAMETERS

U_o	MUST BE LESS THAN OR EQUAL TO 30V
I_o	MUST BE LESS THAN OR EQUAL TO 380 mA
C_o	MUST BE GREATER THAN THE SUM OF $C_i + C_{cable}$
L_o	MUST BE GREATER THAN THE SUM OF $L_i + L_{cable}$

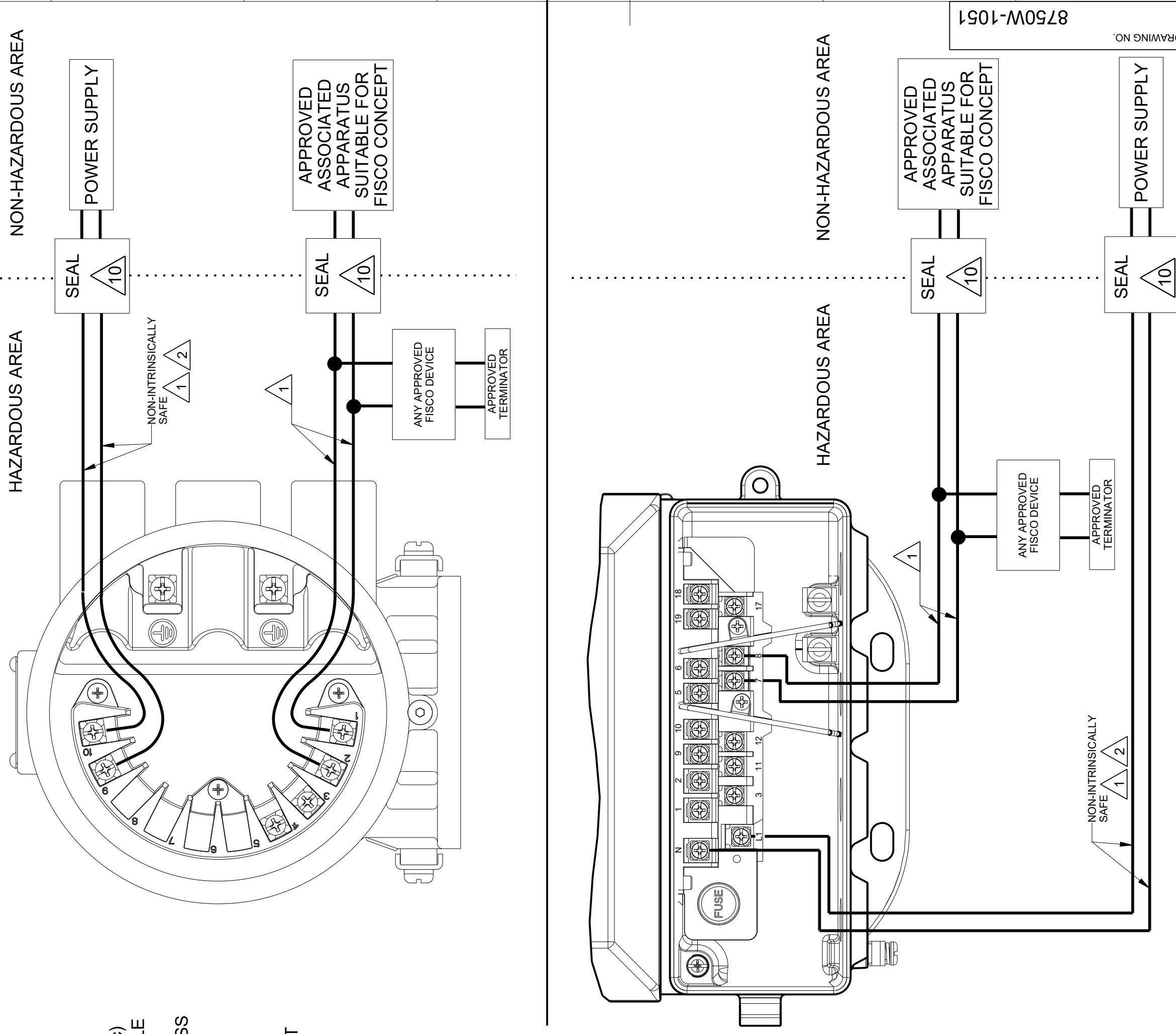

CONFIDENTIAL AND PROPRIETARY INFORMATION IS CONTAINED HEREIN AND MUST BE HANDLED ACCORDINGLY.	SURFACE FINISH UNLESS OTHERWISE SPECIFIED	125	3RD ANGLE	SIZE	C	SCALE	AF	REV	AF
	UNLESS OTHERWISE SPECIFIED DIMENSIONS IN INCHES (mm). REMOVE ALL BURRS AND SHARP EDGES.								
-DEC TOLERANCES-									
X ± .1	[2.5]								
.XX ± .02	[0.5]								
.XXX ± .010	[0.25]								
FRACTIONS ± 1/32	ANGLES ± 2'								
DO NOT SCALE PRINT		CAD MAINTAINED (PROJ)		PRODUCT CODE		SHEET 10 OF 11			
EMERSON		ROSEMOUNT		TITLE		INSTALLATION DRAWING 8750W,		DRAWING NO.	
						CSA CANADIAN AND USA CLASS DIVISION		8750W-1051	
DR.		J. LAGE		9/16/15		DRAWING NO.			
APPD.		M. MAYER		9/16/15		DRAWING NO.			

1	2	3	4	5	6	7	8	9	10	11	12	
A	GAS AND DUST ENVIRONMENT - FM TO CSA COMPATIBILITY											A
B	REPLACEMENT OF FM MARKED 8750WD TRANSMITTERS WITH EQUIVALENT CSA MODEL CODE											B
ORIGINAL MODEL												C
FM RATING												C
APPROVAL MOUNTING CODE	APPROVAL MOUNTING CODE	APPROVAL MOUNTING CODE		APPROVAL MOUNTING CODE		APPROVAL MOUNTING CODE		APPROVAL MOUNTING CODE		APPROVAL MOUNTING CODE		C
Z5	R OR T	Z5 & Z6	R OR T	Z5 & Z6	R OR T	Z5 & Z6	R OR T	Z5 & Z6	R OR T	Z5 & Z6	R OR T	C
Z5	W	Z5 & Z6	W	Z5 & Z6	W	Z5 & Z6	W	Z5 & Z6	W	Z5 & Z6	W	C
Blank		Blank		Blank		Blank		Blank		Blank		C
Ordinary Locations - FM												C
DUST-IGNITION PROOF FOR Class II, III, Div 1, GROUPS E,F, G: T5 NONINCENDIVE FOR CLASS I, DIVISION 2, GROUPS A,B,C,D: T4												C
DUST-IGNITION PROOF FOR Class II, III, Div 1, GROUPS E,F, G: T4 NONINCENDIVE FOR CLASS I, DIVISION 2, GROUPS A,B,C,D: T4												C
Ordinary Locations - CSA												C
REPLACEMENT OF FM MARKED 8750W FLOW TUBES WITH EQUIVALENT CSA MODEL CODE												D
ORIGINAL MODEL												D
FM RATING												D
APPROVAL MOUNTING CODE	APPROVAL MOUNTING CODE	APPROVAL MOUNTING CODE		APPROVAL MOUNTING CODE		APPROVAL MOUNTING CODE		APPROVAL MOUNTING CODE		APPROVAL MOUNTING CODE		D
Z5	F	Z5 & Z6	F	Z5 & Z6	F	Z5 & Z6	F	Z5 & Z6	F	Z5 & Z6	F	D
Blank	F	Blank	F	Blank	F	Blank	F	Blank	F	Blank	F	D
Ordinary Locations - FM												D
DUST-IGNITION PROOF FOR Class II, III, Div 1, GROUPS E,F, G: T5 NONINCENDIVE FOR CLASS I, DIVISION 2, GROUPS A,B,C,D: T4												D
DUST-IGNITION PROOF FOR CLASS I, DIVISION 2, GROUPS A,B,C,D: T4												D
Ordinary Locations - CSA												D
E												E
F												F
G												G
H												H

REPLACEMENT OF FM MARKED 8750WD TRANSMITTERS WITH EQUIVALENT CSA MODEL CODE

CSA REPLACEMENT EQUIVALENCY

APPROVAL MOUNTING CODE	FM RATING	APPROVAL MOUNTING CODE	CSA-US RATING
Z5	DUST-IGNITION PROOF FOR Class II, III, Div 1, GROUPS E,F, G: T5 NONINCENDIVE FOR CLASS I, DIVISION 2, GROUPS A,B,C,D: T4	Z5 & Z6	DUST-IGNITION PROOF FOR Class II, III, Div 1, GROUPS E,F, G: T5 NONINCENDIVE FOR CLASS I, DIVISION 2, GROUPS A,B,C,D: T4
Z5	DUST-IGNITION PROOF FOR Class II, III, Div 1, GROUPS E,F, G: T4 NONINCENDIVE FOR CLASS I, DIVISION 2, GROUPS A,B,C,D: T4	Z5 & Z6	DUST-IGNITION PROOF FOR Class II, III, Div 1, GROUPS E,F, G: T4 NONINCENDIVE FOR CLASS I, DIVISION 2, GROUPS A,B,C,D: T4
Blank	Ordinary Locations - FM	Blank	Ordinary Locations - CSA

REPLACEMENT OF FM MARKED 8750W FLOW TUBES WITH EQUIVALENT CSA MODEL CODE

CSA REPLACEMENT EQUIVALENCY

APPROVAL MOUNTING CODE	FM RATING	APPROVAL MOUNTING CODE	CSA-US RATING
Z5	DUST-IGNITION PROOF FOR Class II, III, Div 1, GROUPS E,F, G: T5 NONINCENDIVE FOR CLASS I, DIVISION 2, GROUPS A,B,C,D: T4	Z5 & Z6	DUST-IGNITION PROOF FOR Class II, III, Div 1, GROUPS E,F, G: T5 NONINCENDIVE FOR CLASS I, DIVISION 2, GROUPS A,B,C,D: T4
Blank	Ordinary Locations - FM	Blank	Ordinary Locations - CSA

DRAWING NO. 8750W-1051

CONFIDENTIAL AND PROPRIETARY INFORMATION IS CONTAINED HEREIN AND MUST BE HANDLED ACCORDINGLY.	SURFACE FINISH UNLESS OTHERWISE SPECIFIED	$\sqrt{125}$	3RD ANGLE		SIZE C	SCALE -	REV AF
ROSEMOUNT							
TITLE INSTALLATION DRAWING 8750W, CSA CANADIAN AND USA CLASS DIVISION							
DR. J. LAGE		9/16/15		DRAWING NO. 8750W-1051			
APPD. M. MAYER		9/16/15		DOC TYPE		SHEET 11 OF 11	
DO NOT SCALE PRINT CAD MAINTAINED (PROJ) PRODUCT CODE							



This page is intentionally blank



This page is intentionally blank



This page is intentionally blank



For more information: www.emerson.com

©2021 Emerson. All rights reserved.
Emerson Terms and Conditions of Sale are available upon request. The Emerson logo is a trademark and service mark of Emerson Electric Co. Rosemount is a mark of one of the Emerson family of companies. All other marks are the property of their respective owners.